

# PRODUCT CATALOG

# 2022



Contains  
Orthodontics  
Consumables  
and  
Orthodontics  
Instruments









## **ABOUT US**

**Orthosmiles was founded on the principle of offering high quality, affordable orthodontic products. Founded in 2013 in Warsaw, Poland, Orthosmiles has been the trusted leader in the field of orthodontic products.**

Utilizing the latest design technologies, our team of skilled and experienced technicians has created a contemporary brand line of high-quality, affordable orthodontic appliances and accessories that are admired by doctors worldwide, and loved by the thousands of patients who have benefited from their use.

Orthosmiles is fully committed to providing unparalleled customer care to each member of our global client network. As such, we take great pride in knowing that each of our customers, whether a small clinic or a major worldwide distributor, receive a level of personalized attention that will ensure their ultimate satisfaction. In doing so, we continue to build new relationships around the world while fostering our reputation as a trusted and reliable source for quality orthodontic appliances.

Our product line includes a full spectrum of orthodontic products and accessories necessary for successful treatments, including brackets, bands, buccal tubes, wires, elastomers, and intra-oral materials.





## TABLE OF CONTENTS

6	Metal Brackets	60	Mini Implants
14	Aesthetic Brackets	68	Instruments
24	Self-Ligating Brackets	76	Instruments (Japan Made)
28	Buccal Tubes		
30	Adhesives		
32	Wires		
38	Elastomerics		
43	Bands & Attachments		
46	Accessories		
56	IPR Systems		

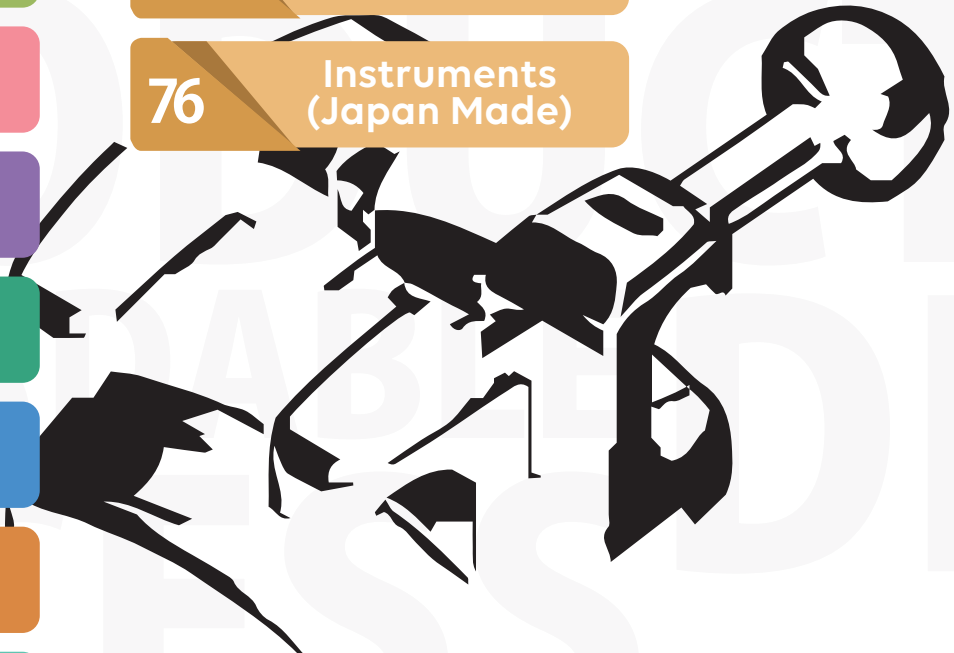

# Metal Brackets

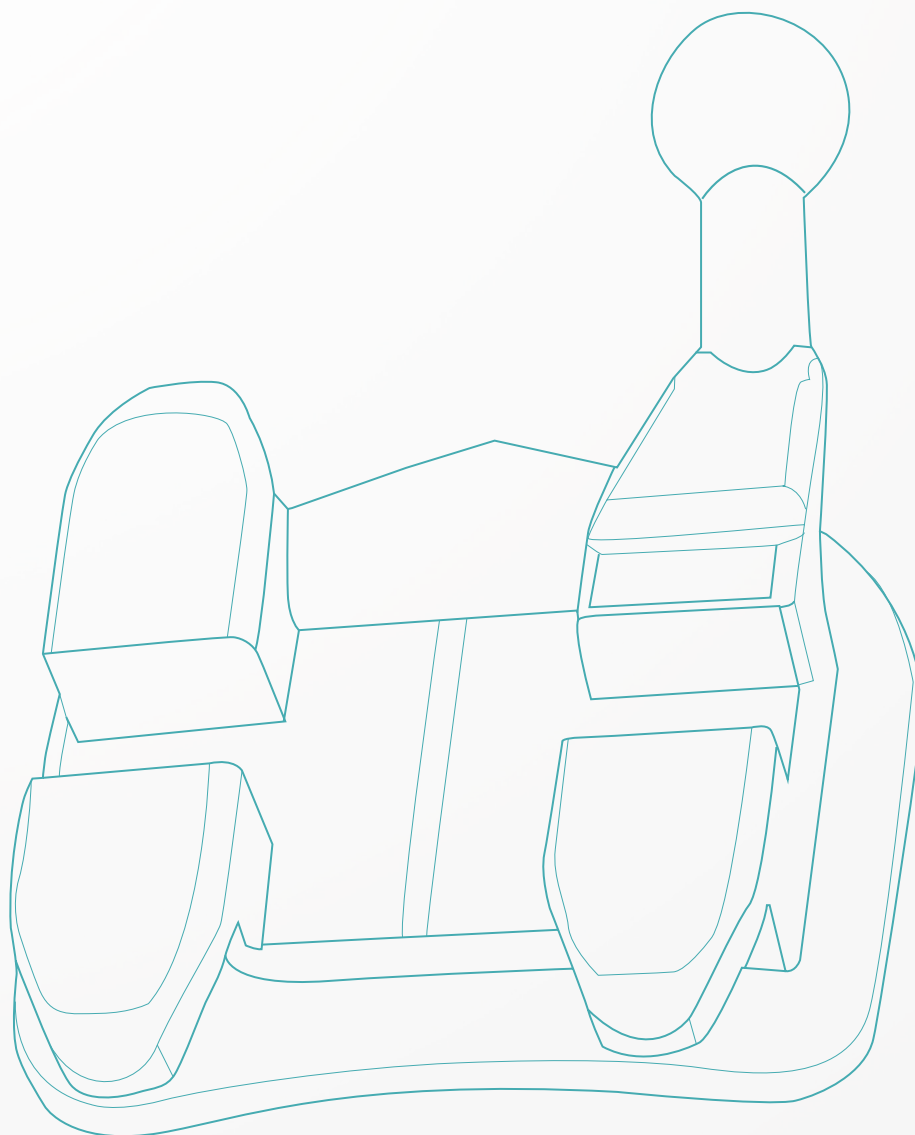



# FDI System

17	16	15	14	13	12	11	21	22	23	24	25	26	27
7	6	5	4	3	2	1	1	2	3	4	5	6	7
7	6	5	4	3	2	1	1	2	3	4	5	6	7
47	46	45	44	43	42	41	31	32	33	34	35	36	37

# Color / Hook Designation





- Made with advanced techniques by Swiss machinery.
- Swiss CNC-machine ensures the accuracy of the bracket slot within 0.02+mm.
- Laser welding from all sides to enhance the welding strength and avoid the problem of loose welding and welding material residues, in comparison to traditional welding way.
- New polishing technique results in minimizing surface roughness, and maximum patient comfort.



## McLaughlin, Bennett, Trevisi System (MBT) Prescription

MAXILLARY	Bracket	Torq.	Ang.	Width (mm)	R/L	.018 Slot		.022 Slot	
						No Hook	With Hook	No Hook	With Hook
Central		+17°	+4°	3.10	R	305-1861		302-2261	
					L	305-1862		302-2262	
Lateral		+10°	+8°	2.80	R	305-1863		302-2263	
					L	305-1864		302-2264	
Cuspid		0°	+8°	2.80	R	305-1865		302-2265	
					L	305-1866		302-2266	
		0°	+8°		R		305-1865H		302-2265H
					L		305-1866H		302-2266H
1st & 2nd Bicuspid		-7°	0°	2.80	R	305-1867		302-2267	
					L	305-1868		302-2268	
					R		305-1867H		302-2267H
					L		305-1868H		302-2268H

MANDIBULAR	Bracket	Torq.	Ang.	Width (mm)	R/L	.018 Slot		.022 Slot	
						No Hook	With Hook	No Hook	With Hook
Anterior		-6°	0°	2.30	R	305-1870		302-2270	
					L	305-1871		302-2271	
Cuspids		-6°	+3°	2.80	R	305-1872		302-2272	
					L	305-1873		302-2273	
					R	305-1872H	305-1872H	302-2272H	302-2272H
					L	305-1873H	305-1873H	302-2273H	302-2273H
1st Bicuspids		-12°	0°	2.80	R	305-1874		302-2274	
					L	305-1875		302-2275	
					R		305-1874H		302-2274H
					L		305-1875H		302-2275H
2nd Bicuspids		-17°	0°	2.80	R	305-1876		302-2276	
					L	305-1877		302-2277	
					R		305-1876H		302-2276H
					L		305-1877H		302-2277H





BRACKET KITS	TYPE	0.018 SLOT		0.022 SLOT	
		ROTH	MBT	ROTH	MBT
	Upper & Lower with Hook on 3	OR-HS-204B	OR-HS-205B	OR-HS-201B	OR-HS-202B
Upper & Lower with Hook on 3, 4 & 5	OR-HS-204	OR-HS-205	OR-HS-201	OR-HS-202	

Roth Prescription

MAXILLARY	Bracket	Torq.	Ang.	Width (mm)	R/L	.018 Slot		.022 Slot	
						No Hook	With Hook	No Hook	With Hook
	Central		+12°	+5°	3.43	R	304-1841		301-2241
L						304-1842		301-2242	
Lateral		+8°	+9°	2.7	R	304-1843		301-2243	
					L	304-1844		301-2244	
Cuspid		-2°	+10°	3.26	R	304-1845		301-2245	
					L	304-1846		301-2246	
					R		304-1845H		301-2245H
					L		304-1846H		301-2246H
1st & 2nd Bicuspid		-7°	0°	3.00	R	304-1847		301-2247	
					L	304-1848		301-2248	
					R		304-1847H		301-2247H
					L		304-1848H		301-2248H

MANDIBULAR	Bracket	Torq.	Ang.	Width (mm)	R/L	.018 Slot		.022 Slot	
						No Hook	With Hook	No Hook	With Hook
	Anterior		-1°	0°	2.50	R	304-1850		301-2250
L						304-1851		301-2251	
Cuspids		-11°	+7°	3.23	R	304-1852		301-2252	
					L	304-1853		301-2253	
					R		304-1852H		301-2252H
					L		304-1853H		301-2253H
1st Bicuspids		-17°	0°	3.12	R	304-1854		301-2254	
					L	304-1855		301-2255	
					R		304-1854H		301-2254H
					L		304-1855H		301-2255H
2nd Bicuspids		-22°	0°	3.13	R	304-1856		301-2256	
					L	304-1857		301-2257	
					R		304-1856H		301-2256H
					L		304-1857H		301-2257H



- CNC technology, ensures the accuracy of slot size and more perfect radian.
- Smooth surface and low profile design, to improve the comfort of patients.
- Four-wing design, to satisfy different traction and ligation.
- New polishing technique results in minimizing surface roughness, and maximum patient comfort.



## McLaughlin, Bennett, Trevisi System (MBT) Prescription

MAXILLARY	Bracket	Torq.	Ang.	Width (mm)	R/L	.018 Slot		.022 Slot	
						No Hook	With Hook	No Hook	With Hook
	Central	+17°	+4°	3.10	R	205-1861		202-2261	
					L	205-1862		202-2262	
	Lateral	+10°	+8°	2.80	R	205-1863		202-2263	
					L	205-1864		202-2264	
	Cuspid	0°	+8°	2.80	R	205-1865		202-2265	
					L	205-1866		202-2266	
		0°	+8°		R		205-1865H		202-2265H
					L		205-1866H		202-2266H
1st & 2nd Bicuspid	-7°	0°	2.80	R	205-1867		202-2267		
				L	205-1868		202-2268		
				R		205-1867H		202-2267H	
				L		205-1868H		202-2268H	

MANDIBULAR	Bracket	Torq.	Ang.	Width (mm)	R/L	.018 Slot		.022 Slot	
						No Hook	With Hook	No Hook	With Hook
	Anterior	-6°	0°	2.30	R	205-1870		202-2270	
					L	205-1871		202-2271	
	Cuspids	-6°	+3°	2.80	R	205-1872		202-2272	
					L	205-1873		202-2273	
					R		205-1872H		202-2272H
					L		205-1873H		202-2273H
	1st Bicuspids	-12°	0°	2.80	R	205-1874		202-2274	
					L	205-1875		202-2275	
R						205-1874H		202-2274H	
L						205-1875H		202-2275H	
2nd Bicuspids	-17°	0°	2.80	R	205-1876		202-2276		
				L	205-1877		202-2277		
				R		205-1876H		202-2276H	
				L		205-1877H		202-2277H	





BRACKET KITS	TYPE	0.018 SLOT		0.022 SLOT	
		ROTH	MBT	ROTH	MBT
	Upper & Lower with Hook on 3	OR-MS-204B	OR-MS-205B	OR-MS-201B	OR-MS-202B
Upper & Lower with Hook on 3, 4 & 5	OR-MS-204	OR-MS-205	OR-MS-201	OR-MS-202	

Roth Prescription

MAXILLARY	Bracket	Torq.	Ang.	Width (mm)	R/L	.018 Slot		.022 Slot	
						No Hook	With Hook	No Hook	With Hook
						Central	+12°	+5°	3.10
Lateral	+8°	+9°	2.80	R	204-1843		201-2243		
				L	204-1844		201-2244		
Cuspid	-2°	+11°	2.80	R	204-1845		201-2245		
				L	204-1846		201-2246		
				R		204-1845H		201-2245H	
				L		204-1846H		201-2246H	
1st & 2nd Bicuspid	-7°	0°	2.80	R	204-1847		201-2247		
				L	204-1848		201-2248		
				R		204-1847H		201-2247H	
				L		204-1848H		201-2248H	

MANDIBULAR	Bracket	Torq.	Ang.	Width (mm)	R/L	.018 Slot		.022 Slot	
						No Hook	With Hook	No Hook	With Hook
						Anterior	-1°	0°	2.80
Cuspids	-11°	+5°	2.80	L	204-1851		201-2251		
				R	204-1852		201-2252		
				L	204-1853		201-2253		
				R		204-1852H		201-2252H	
1st Bicuspids	-17°	0°	2.80	L		204-1853H		201-2253H	
				R	204-1854		201-2254		
				L	204-1855		201-2255		
				R		204-1854H		201-2254H	
2nd Bicuspids	-22°	0°	2.80	L		204-1855H		201-2255H	
				R	204-1856		201-2256		
				L	204-1857		201-2257		
				R		204-1856H		201-2256H	
				L		204-1857H		201-2257H	



- Torque in base for level slot lineup
- 80 gauge mesh bonding base to match the anatomy of the tooth for maximum contact and a strong, consistent bond
- Rounded tie wing for patient comfort

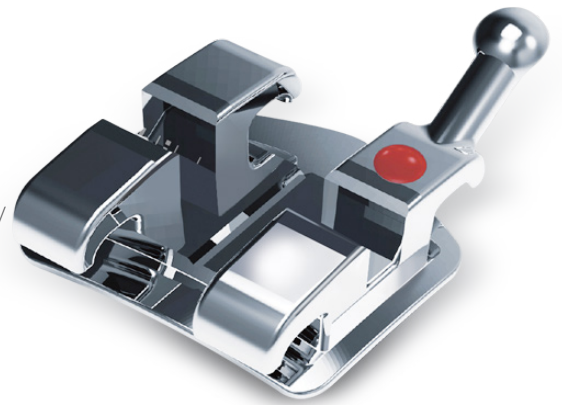

**McLaughlin, Bennett, Trevisi System (MBT) Prescription**

MAXILLARY	Tooth	Torq.	Ang.	M/D Width	R/L	.018 Slot		0.022 Slot	
						No Hook	With Hook	No Hook	With Hook
						Central	17°	4°	3.6
				L	214-1822		211-2222		
Lateral	10°	9°	2.8	R	214-1823		211-2223		
				L	214-1824		211-2224		
Cuspid	-7°	8°	3.0	R	214-1825		211-2225		
				L	214-1826		211-2226		
	0°	0°		R		214-1825H		211-2225H	
				L		214-1826H		211-2226H	
1st & 2nd Bicuspid	-7°	0°	3.0	R	214-1827		211-2227		
				L	214-1828		211-2228		
				R		214-1827H		211-2227H	
				L		214-1828H		211-2228H	

MANDIBULAR	Tooth	Torq.	Ang.	M/D Width	R/L	.018 Slot		0.022 Slot	
						No Hook	With Hook	No Hook	With Hook
						Anterior	-6°	0°	3.6
				L	214-1831		211-2231		
Cuspids	-6°	3°	3.0	R	214-1832		211-2232		
				L	214-1833		211-2233		
	0°	0°		R		214-1832H		211-2232H	
				L		214-1833H		211-2233H	
1st Bicuspids	-12°	3°	3.0	R	214-1834		211-2234		
				L	214-1835		211-2235		
				R		214-1834H		211-2234H	
				L		214-1835H		211-2235H	
2nd Bicuspids	-17°	3°	3.0	R	214-1836		211-2236		
				L	214-1837		211-2237		
				R		214-1836H		211-2236H	
				L		214-1837H		211-2237H	





BRACKET KITS	TYPE	0.018 SLOT		0.022 SLOT	
		ROTH	MBT	ROTH	MBT
	Upper & Lower with Hook on 3	OR-TS-213B	OR-TS-214B	OR-TS-210B	OR-TS-211B
Upper & Lower with Hook on 3, 4 & 5	OR-TS-213	OR-TS-214	OR-TS-210	OR-TS-211	

Roth Prescription

MAXILLARY	Bracket	Torq.	Ang.	Width (mm)	R/L	.018 Slot		.022 Slot	
						No Hook	With Hook	No Hook	With Hook
	Central		+12°	+5°	3.10	R	213-1801		210-2201
L						213-1802		210-2202	
Lateral		+8°	+9°	2.80	R	213-1803		210-2203	
					L	213-1804		210-2204	
Cuspid		-2°	+11°	2.80	R	213-1805		210-2205	
					L	213-1806		210-2206	
					R		213-1805H		210-2205H
					L		213-1806H		210-2206H
1st & 2nd Bicuspid		-7°	0°	2.80	R	213-1807		210-2207	
					L	213-1808		210-2208	
					R		213-1807H		210-2207H
					L		213-1808H		210-2208H

MANDIBULAR	Bracket	Torq.	Ang.	Width (mm)	R/L	.018 Slot		.022 Slot	
						No Hook	With Hook	No Hook	With Hook
	Anterior		-1°	0°	2.80	R	213-1810		210-2210
L						213-1811		210-2211	
Cuspids		-11°	+5°	2.80	R	213-1812		210-2212	
					L	213-1813		210-2213	
					R		213-1812H		210-2212H
					L		213-1813H		210-2213H
1st Bicuspids		-17°	0°	2.80	R	213-1814		210-2214	
					L	213-1815		210-2215	
					R		213-1814H		210-2214H
					L		213-1815H		210-2215H
2nd Bicuspids		-22°	0°	2.80	R	213-1816		210-2216	
					L	213-1817		210-2217	
					R		213-1816H		210-2216H
					L		213-1817H		210-2217H

# Aesthetic Braces

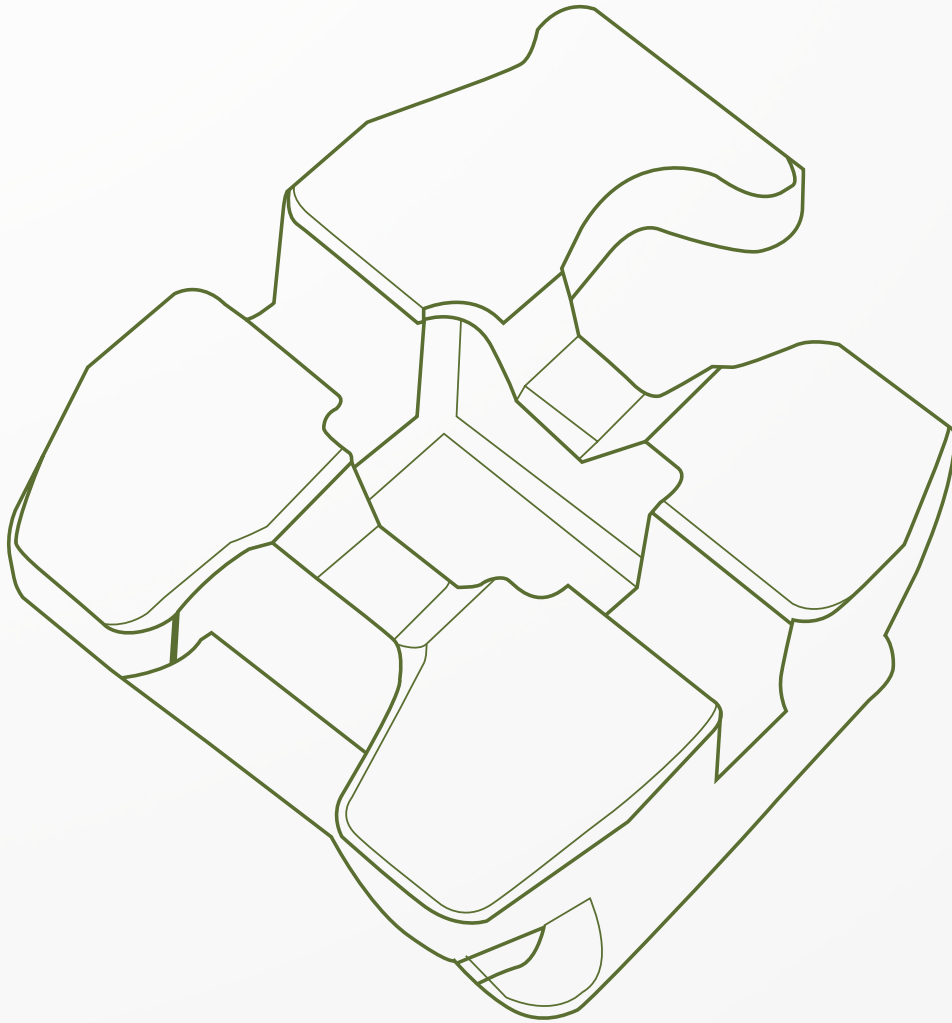

 **KLAROWNY**  
CERAMIC BRACKETS

 **GLOSS**  
Sapphire Brackets

## FDI System

17	16	15	14	13	12	11	21	22	23	24	25	26	27
7	6	5	4	3	2	1	1	2	3	4	5	6	7
7	6	5	4	3	2	1	1	2	3	4	5	6	7
47	46	45	44	43	42	41	31	32	33	34	35	36	37

## Hook Designation

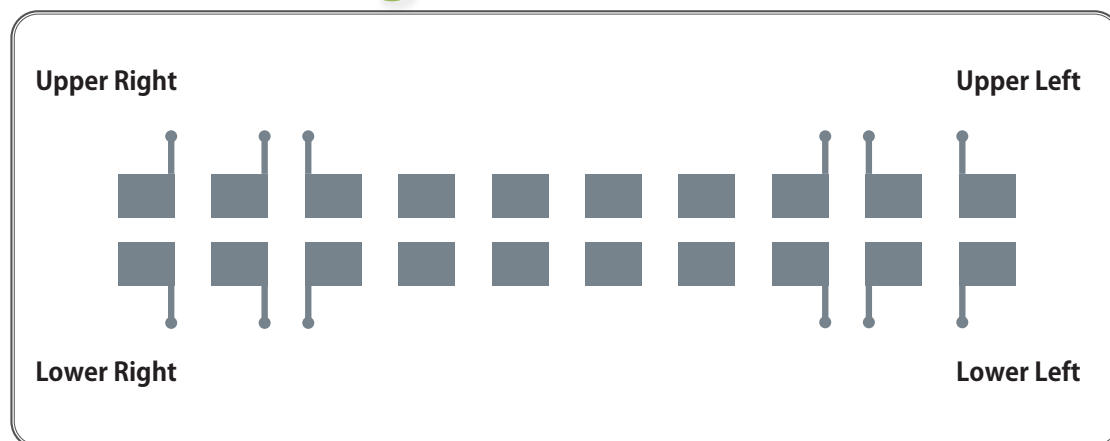



**KLAROWNY<sup>S</sup>**  
CERAMIC 3LINE BASE

- True twin wings for flexible treatment and ligation.
- Rounded edge for patient comfort.
- Hollow design in slot center to reduce the frictional force.
- Ceramic Injection Method (CIM Method) for remarkable durability.



**McLaughlin, Bennett, Trevisi System (MBT) Prescription**

MAXILLARY	Tooth	Torq.	Ang.	M/D Width	R/L	.018 Slot		0.022 Slot	
						No Hook	With Hook	No Hook	With Hook
	Central	17°	4°	3.6	R	225-1801		222-2201	
					L	225-1802		222-2202	
	Lateral	10°	9°	2.8	R	225-1803		222-2203	
					L	225-1804		222-2204	
	Cuspid	-7°	8°	3.0	R	225-1805		222-2205	
					L	225-1806		222-2206	
		0°	0°		R		225-1805H		222-2205H
					L		225-1806H		222-2206H
1st & 2nd Bicuspid	-7°	0°	3.0	R	225-1807		222-2207		
				L	225-1808		222-2208		
				R		225-1807H		222-2207H	
				L		225-1808H		222-2208H	

MANDIBULAR	Tooth	Torq.	Ang.	M/D Width	R/L	.018 Slot		0.022 Slot	
						No Hook	With Hook	No Hook	With Hook
	Anterior	-6°	0°	3.6	R	225-1810		222-2210	
					L	225-1811		222-2211	
	Cuspids	-6°	3°	3.0	R	225-1812		222-2212	
					L	225-1813		222-2213	
		0°	0°		R		225-1812H		222-2212H
					L		225-1813H		222-2213H
	1st Bicuspids	-12°	3°	3.0	R	225-1814		222-2214	
					L	225-1815		222-2215	
R						225-1814H		222-2214H	
L						225-1815H		222-2215H	
2nd Bicuspids	-17°	3°	3.0	R	225-1816		222-2216		
				L	225-1817		222-2217		
				R		225-1816H		222-2216H	
				L		225-1817H		222-2217H	

BRACKET KITS	TYPE	0.018 SLOT		0.022 SLOT	
		ROTH	MBT	ROTH	MBT
	Upper & Lower with Hook on 3	OR-KS-224B	OR-KS-225B	OR-KS-221B	OR-KS-222B
Upper & Lower with Hook on 3, 4 & 5	OR-KS-224	OR-KS-225	OR-KS-221	OR-KS-222	

**Roth Prescription**

MAXILLARY	Bracket	Torq.	Ang.	Width (mm)	R/L	.018 Slot		.022 Slot	
						No Hook	With Hook	No Hook	With Hook
	Central		+12°	+5°	3.10	R	224-1881		221-2281
L						224-1882		221-2282	
Lateral		+8°	+9°	2.80	R	224-1883		221-2283	
					L	224-1884		221-2284	
Cuspid		-2°	+11°	2.80	R	224-1885		221-2285	
					L	224-1886		221-2286	
					R		224-1885H		221-2285H
					L		224-1886H		221-2286H
1st & 2nd Bicuspid		-7°	0°	2.80	R	224-1887		221-2287	
					L	224-1888		221-2288	
					R		224-1887H		221-2287H
					L		224-1888H		221-2288H

MANDIBULAR	Bracket	Torq.	Ang.	Width (mm)	R/L	.018 Slot		.022 Slot	
						No Hook	With Hook	No Hook	With Hook
	Anterior		-1°	0°	2.80	R	224-1890		221-2290
L						224-1891		221-2291	
Cuspids		-11°	+5°	2.80	R	224-1892		221-2292	
					L	224-1893		221-2293	
					R		224-1892H		221-2292H
					L		224-1893H		221-2293H
1st Bicuspids		-17°	0°	2.80	R	224-1894		221-2294	
					L	224-1895		221-2295	
					R		224-1894H		221-2294H
					L		224-1895H		221-2295H
2nd Bicuspids		-22°	0°	2.80	R	224-1896		221-2296	
					L	224-1897		221-2297	
					R		224-1896H		221-2296H
					L		224-1897H		221-2297H



- Ceramic aesthetic bracket, CIM Technology, accurate data.
- Four-wing perfect arc-shaped design for more comfortable wearing.
- Clear color identification system, advanced polishing technology for smooth bracket surface.



## McLaughlin, Bennett, Trevisi System (MBT) Prescription

MAXILLARY	Tooth	Torq.	Ang.	M/D Width	R/L	.018 Slot		0.022 Slot	
						No Hook	With Hook	No Hook	With Hook
						Central	17°	4°	3.2
				L	325-1802		322-2202		
Lateral	10°	8°	2.8	R	325-1803		322-2203		
				L	325-1804		322-2204		
Cuspid	-7°	8°	2.8	R	325-1805		322-2205		
				L	325-1806		322-2206		
				R		325-1805H		322-2205H	
				L		325-1806H		322-2206H	
1st & 2nd Bicuspid	-7°	0°	2.8	R	325-1807		322-2207		
				L	325-1808		322-2208		
				R		325-1807H		322-2207H	
				L		325-1808H		322-2208H	

MANDIBULAR	Tooth	Torq.	Ang.	M/D Width	R/L	.018 Slot		0.022 Slot	
						No Hook	With Hook	No Hook	With Hook
						Anterior	-6°	0°	2.85
				L	325-1811		322-2211		
Cuspids	-6°	3°	3.5	R	325-1812		322-2212		
				L	325-1813		322-2213		
				R		325-1812H		322-2212H	
				L		325-1813H		322-2213H	
1st Bicuspids	-12°	2°	3.2	R	325-1814		322-2214		
				L	325-1815		322-2215		
				R		325-1814H		322-2214H	
				L		325-1815H		322-2215H	
2nd Bicuspids	-17°	2°	3.2	R	325-1816		322-2216		
				L	325-1817		322-2217		
				R		325-1816H		322-2216H	
				L		325-1817H		322-2217H	



BRACKET KITS	TYPE	0.018 SLOT		0.022 SLOT	
		ROTH	MBT	ROTH	MBT
	Upper & Lower with Hook on 3	OR-KSP-224B	OR-KSP-225B	OR-KSP-221B	OR-KS-222B
Upper & Lower with Hook on 3, 4 & 5	OR-KSP-224	OR-KSP-225	OR-KSP-221	OR-KSP-222	

Roth Prescription

MAXILLARY	Bracket	Torq.	Ang.	Width (mm)	R/L	.018 Slot		.022 Slot	
						No Hook	With Hook	No Hook	With Hook
	Central		+12°	+5°	3.5	R	324-1881		321-2281
L						324-1882		321-2282	
Lateral		+8°	+9°	3.0	R	324-1883		321-2283	
					L	324-1884		321-2284	
Cuspid		-2°	+10°	3.0	R	324-1885		321-2285	
					L	324-1886		321-2286	
					R		324-1885H		321-2285H
					L		324-1886H		321-2286H
1st & 2nd Bicuspid		-7°	0°	3.5	R	324-1887		321-2287	
					L	324-1888		321-2288	
					R		324-1887H		321-2287H
					L		324-1888H		321-2288H

MANDIBULAR	Bracket	Torq.	Ang.	Width (mm)	R/L	.018 Slot		.022 Slot	
						No Hook	With Hook	No Hook	With Hook
	Anterior		-1°	0°	2.85	R	324-1890		321-2290
L						324-1891		321-2291	
Cuspids		-11°	+7°	3.5	R	324-1892		321-2292	
					L	324-1893		321-2293	
					R		324-1892H		321-2292H
					L		324-1893H		321-2293H
1st Bicuspids		-17°	0°	3.5	R	324-1894		321-2294	
					L	324-1895		321-2295	
					R		324-1894H		321-2294H
					L		324-1895H		321-2295H
2nd Bicuspids		-22°	+6°	3.4	R	324-1896		321-2296	
					L	324-1897		321-2297	
					R		324-1896H		321-2296H
					L		324-1897H		321-2297H



**KLAROWNY<sup>MS</sup>**  
METAL SLOT BRACKET

- Metal slot for flexible treatment and ligation.
- Rounded edge for patient comfort.
- Hollow design in slot center to reduce the frictional force.
- Ceramic Injection Method (CIM Method) for remarkable durability.



**McLaughlin, Bennett, Trevisi System (MBT) Prescription**

MAXILLARY	Tooth	Torq.	Ang.	M/D Width	R/L	.018 Slot		0.022 Slot	
						No Hook	With Hook	No Hook	With Hook
	Central	17°	4°	3.2	R	425-1801		422-2201	
					L	425-1802		422-2202	
	Lateral	10°	8°	2.8	R	425-1803		422-2203	
					L	425-1804		422-2204	
	Cuspid	-7°	8°	2.8	R	425-1805		422-2205	
					L	425-1806		422-2206	
					R		425-1805H		422-2205H
					L		425-1806H		422-2206H
1st & 2nd Bicuspid	-7°	0°	2.8	R	425-1807		422-2207		
				L	425-1808		422-2208		
				R		425-1807H		422-2207H	
				L		425-1808H		422-2208H	

MANDIBULAR	Tooth	Torq.	Ang.	M/D Width	R/L	.018 Slot		0.022 Slot	
						No Hook	With Hook	No Hook	With Hook
	Anterior	-6°	0°	2.85	R	425-1810		422-2210	
					L	425-1811		422-2211	
	Cuspids	-6°	3°	3.5	R	425-1812		422-2212	
					L	425-1813		422-2213	
					R		425-1812H		422-2212H
					L		425-1813H		422-2213H
	1st Bicuspids	-12°	2°	3.2	R	425-1814		422-2214	
					L	425-1815		422-2215	
R						425-1814H		422-2214H	
L						425-1815H		422-2215H	
2nd Bicuspids	-17°	2°	3.2	R	425-1816		422-2216		
				L	425-1817		422-2217		
				R		425-1816H		422-2216H	
				L		425-1817H		422-2217H	

BRACKET KITS	TYPE	0.018 SLOT		0.022 SLOT	
		ROTH	MBT	ROTH	MBT
	Upper & Lower with Hook on 3	OR-KS-224B-N	OR-KS-225B-N	OR-KS-221B-N	OR-KS-222B-N
Upper & Lower with Hook on 3, 4 & 5	OR-KS-224-N	OR-KS-225-N	OR-KS-221-N	OR-KS-222-N	

Roth Prescription

MAXILLARY	Bracket	Torq.	Ang.	Width (mm)	R/L	.018 Slot		.022 Slot	
						No Hook	With Hook	No Hook	With Hook
	Central		+12°	+5°	3.5	R	424-1881		421-2281
L						424-1882		421-2282	
Lateral		+8°	+9°	3.0	R	424-1883		421-2283	
					L	424-1884		421-2284	
Cuspid		-2°	+10°	3.0	R	424-1885		421-2285	
					L	424-1886		421-2286	
					R		424-1885H		421-2285H
					L		424-1886H		421-2286H
1st & 2nd Bicuspid		-7°	0°	3.5	R	424-1887		421-2287	
					L	424-1888		421-2288	
					R		424-1887H		421-2287H
					L		424-1888H		421-2288H

MANDIBULAR	Bracket	Torq.	Ang.	Width (mm)	R/L	.018 Slot		.022 Slot	
						No Hook	With Hook	No Hook	With Hook
	Anterior		-1°	0°	2.85	R	424-1890		421-2290
L						424-1891		421-2291	
Cuspids		-11°	+7°	3.5	R	424-1892		421-2292	
					L	424-1893		421-2293	
					R		424-1892H		421-2292H
					L		424-1893H		421-2293H
1st Bicuspids		-17°	0°	3.5	R	424-1894		421-2294	
					L	424-1895		421-2295	
					R		424-1894H		421-2294H
					L		424-1895H		421-2295H
2nd Bicuspids		-22°	+6°	3.4	R	424-1896		421-2296	
					L	424-1897		421-2297	
					R		424-1896H		421-2296H
					L		424-1897H		421-2297H

# GLOSS

Sapphire Brackets



- Rounded edge and full body coating giving ultra-smooth comfort for the patient.
- True twin wings for excellent performance.
- True Clear sapphire brackets for aesthetic look.

## McLaughlin, Bennett, Trevisi System (MBT) Prescription

MAXILLARY	Tooth	Torq.	Ang.	M/D Width	Hook	R/L	.018 Slot		0.022 Slot	
							No Hook	With Hook	No Hook	With Hook
							Central	17°	4°	3.6
				-	L	235-1842		232-2242		
Lateral	10°	9°	2.8	-	R	235-1843		232-2243		
				-	L	235-1844		232-2244		
Cuspid	-7°	8°	3.0	-	R	235-1845		232-2245		
				-	L	235-1846		232-2246		
	0°	0°		W	R		235-1845H		232-2245H	
				W	L		235-1846H		232-2246H	
1st & 2nd Bicuspid	-7°	0°	3.0	-	R	235-1847		232-2247		
				-	L	235-1848		232-2248		
				W	R		235-1847H		232-2247H	
				W	L		235-1848H		232-2248H	

MANDIBULAR	Tooth	Torq.	Ang.	M/D Width	Hook	R/L	.018 Slot		0.022 Slot	
							No Hook	With Hook	No Hook	With Hook
							Anterior	-6°	0°	3.6
				-	L	235-1851		232-2251		
Cuspids	-6°	3°	3.0	-	R	235-1852		232-2252		
				-	L	235-1853		232-2253		
	0°			W	R		235-1852H		232-2252H	
				W	L		235-1853H		232-2253H	
1st Bicuspids	-12°	3°	3.0	-	R	235-1854		232-2254		
				-	L	235-1855		232-2255		
				W	R		235-1854H		232-2254H	
				W	L		235-1855H		232-2255H	
2nd Bicuspids	-17°	3°	3.0	-	R	235-1856		232-2256		
				-	L	235-1857		232-2257		
				W	R		235-1856H		232-2256H	
				W	L		235-1857H		232-2257H	



BRACKET KITS	TYPE	0.018 SLOT		0.022 SLOT	
		ROTH	MBT	ROTH	MBT
	Upper & Lower with Hook on 3	OR-R18B	OR-M18B	OR-R22B	OR-M22B
Upper & Lower with Hook on 3, 4 & 5	OR-R18	OR-M18	OR-R22	OR-M22	

Roth Prescription

MAXILLARY	Bracket	Torq.	Ang.	Width (mm)	R/L	.018 Slot		.022 Slot	
						No Hook	With Hook	No Hook	With Hook
						Central	+12°	+5°	3.10
Lateral	+8°	+9°	2.80	R	234-1823		231-2223		
				L	234-1824		231-2224		
Cuspid	-2°	+11°	2.80	R	234-1825		231-2225		
				L	234-1826		231-2226		
				R		234-1825H		231-2225H	
				L		234-1826H		231-2226H	
1st & 2nd Bicuspid	-7°	0°	2.80	R	234-1827		231-2227		
				L	234-1828		231-2228		
				R		234-1827H		231-2227H	
				L		234-1828H		231-2228H	

MANDIBULAR	Bracket	Torq.	Ang.	Width (mm)	R/L	.018 Slot		.022 Slot	
						No Hook	With Hook	No Hook	With Hook
						Anterior	-1°	0°	2.80
Cuspids	-11°	+5°	2.80	L	234-1831		231-2231		
				R	234-1832		231-2232		
				L	234-1833		231-2233		
				R		234-1832H		231-2232H	
1st Bicuspids	-17°	0°	2.80	L		234-1833H		231-2233H	
				R	234-1834		231-2234		
				L	234-1835		231-2235		
				R		234-1834H		231-2234H	
2nd Bicuspids	-22°	0°	2.80	L		234-1835H		231-2235H	
				R	234-1836		231-2236		
				L	234-1837		231-2237		
				R		234-1836H		231-2236H	
L		234-1837H		231-2237H					



# Self-Ligating Braces

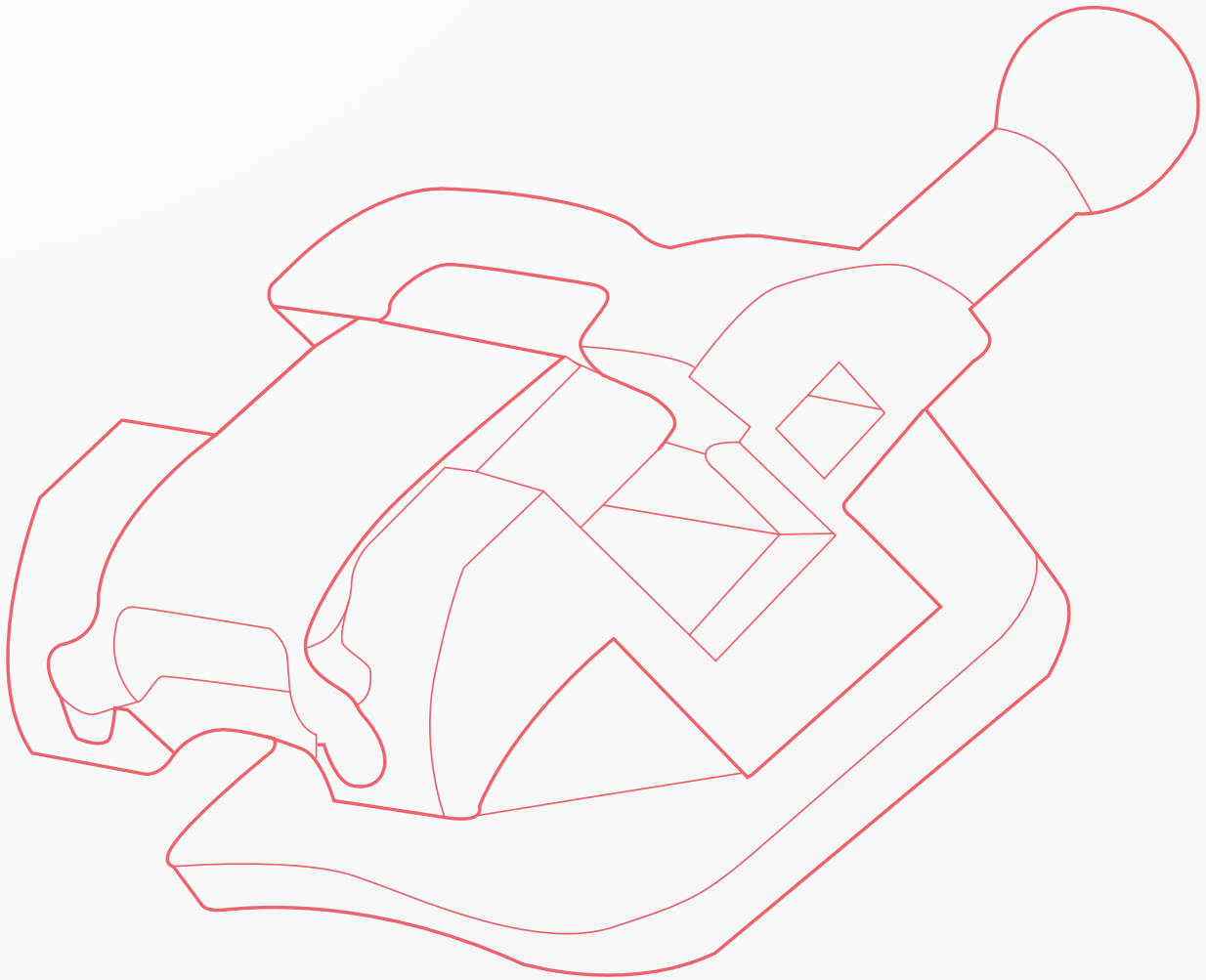



Sliding cover can ensure the convenience of placing and removing archwires, improve the comfort of the patient and lessen the treatment duration.

Innovative auxiliary hole design, to increase the operability of special cases.

Smooth and round edges, to reduce mucosal irritation and bring more comfort to the patient.

Laser welding process, to prevent food residues.

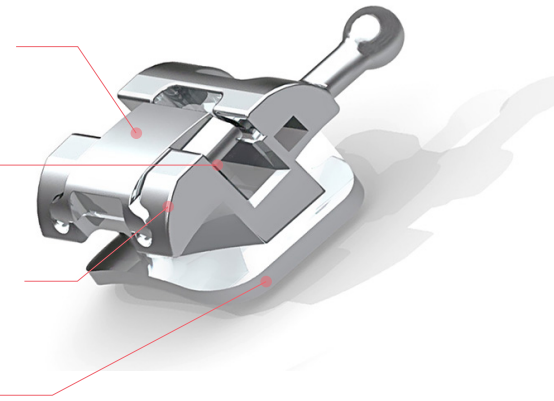

FULL SET			
Standard Torque Passive	TYPE	0.018 SLOT	0.022 SLOT
	Upper & Lower without Hook	-	OR-VM-503A
	Upper & Lower with Hook on 3	-	OR-VM-503B
	Upper & Lower with Hook on 3, 4 & 5	-	OR-VM-503C

STANDARD TORQUE PASSIVE									
	Tooth	Torq.	Ang.	M/D Width	Hook	.018 Slot		0.022 Slot	
						RIGHT	LEFT	RIGHT	LEFT
MAXILLARY	Central	+15°	+5°	3.1	-	-	-	503-211	503-221
	Lateral	+6°	+9°	2.8	-	-	-	503-212	503-222
	Cuspid	+7°	+5°	3.1	-	-	-	503-213	503-223
					W	-	-	503-213H	503-223H
	1st Bicuspid	-11°	+2°	2.9	-	-	-	503-214	503-224
					W	-	-	503-214H	503-224H
2nd Bicuspid	-11°	+2°	2.9	-	-	-	503-215	503-225	
W	-	-	-	-	-	503-215H	503-225H		
MANDIBULAR	Central	-3°	+2°	2.8	-	-	-	503-241	503-231
	Lateral	-3°	+2°	2.8	-	-	-	503-242	503-232
	Cuspid	+7°	+5°	3.1	-	-	-	503-243	503-233
					W	-	-	503-243H	503-233H
	1st Bicuspid	-12°	+4°	2.9	-	-	-	503-244	503-234
					W	-	-	503-244H	503-234H
2nd Bicuspid	-17°	+4°	2.9	-	-	-	503-245	503-235	
W	-	-	-	-	-	503-245H	503-235H		

OPEN / CLOSED COVER TECHNOLOGY

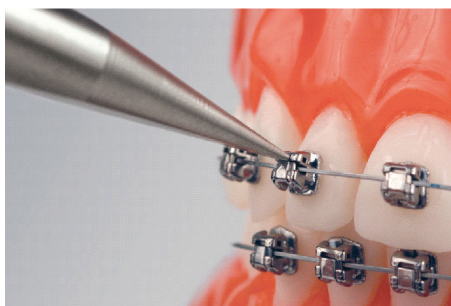

Opening Step 1

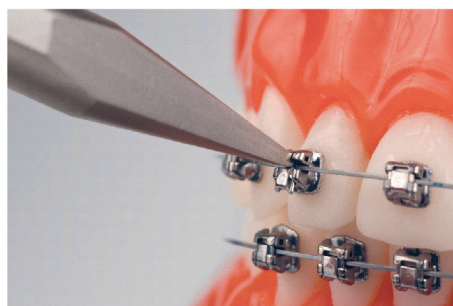

Opening Step 2

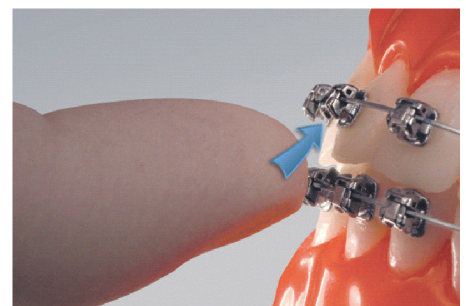

Closing

LOW TORQUE PASSIVE									
MAXILLARY	Tooth	Torq.	Ang.	M/D Width	Hook	.018 Slot		0.022 Slot	
						RIGHT	LEFT	RIGHT	LEFT
	Central	+2°	+5°	3.1	-	-	-	504-211	504-221
Lateral	-5°	+9°	2.8	-	-	-	504-212	504-222	
Cuspid	-7°	+5°	3.1	-	-	-	504-213	504-223	
				W	-	-	504-213H	504-223H	
1st Bicuspid	-11°	+2°	2.9	-	-	-	504-214	504-224	
				W	-	-	504-214H	504-224H	
2nd Bicuspid	-11°	+2°	2.9	-	-	-	504-215	504-225	
				W	-	-	504-215H	504-225H	
MANDIBULAR	Central	-11°	+2°	2.8	-	-	504-241	504-231	
	Lateral	-11°	+2°	2.8	-	-	504-242	504-232	
	Cuspid	0°	+5°	3.1	-	-	-	504-243	504-233
					W	-	-	504-243H	504-233H
	1st Bicuspid	-12°	+4°	2.9	-	-	-	504-244	504-234
					W	-	-	504-244H	504-234H
2nd Bicuspid	-17°	+4°	2.9	-	-	-	504-245	504-235	
				W	-	-	504-245H	504-235H	

FULL SET				
Low Torque Passive	TYPE		0.018 SLOT	0.022 SLOT
	Upper & Lower without Hook		-	OR-VM-504A
	Upper & Lower with Hook on 3		-	OR-VM-504B
	Upper & Lower with Hook on 3, 4 & 5		-	OR-VM-504C

HIGH TORQUE PASSIVE									
MAXILLARY	Tooth	Torq.	Ang.	M/D Width	Hook	.018 Slot		0.022 Slot	
						RIGHT	LEFT	RIGHT	LEFT
	Central	+15°	+5°	3.1	-	-	-	505-211	505-221
Lateral	+10°	+9°	2.8	-	-	-	505-212	505-222	
Cuspid	+7°	+10°	3.1	-	-	-	505-213	505-223	
				W	-	-	505-213H	505-223H	
1st Bicuspid	-7°	+2°	2.9	-	-	-	505-214	505-224	
				W	-	-	505-214H	505-224H	
2nd Bicuspid	-7°	+2°	2.9	-	-	-	505-215	505-225	
				W	-	-	505-215H	505-225H	
MANDIBULAR	Central	-6°	+2°	2.8	-	-	505-241	505-231	
	Lateral	-6°	+2°	2.8	-	-	505-242	505-232	
	Cuspid	+7°	+5°	3.1	-	-	-	505-243	505-233
					W	-	-	505-243H	505-233H
	1st Bicuspid	-12°	+4°	2.9	-	-	-	505-244	505-234
					W	-	-	505-244H	505-234H
2nd Bicuspid	-17°	+4°	2.9	-	-	-	505-245	505-235	
				W	-	-	505-245H	505-235H	

FULL SET				
High Torque Passive	TYPE		0.018 SLOT	0.022 SLOT
	Upper & Lower without Hook		-	OR-VM-505A
	Upper & Lower with Hook on 3		-	OR-VM-505B
	Upper & Lower with Hook on 3, 4 & 5		-	OR-VM-505C



Manufactured by ceramic injection molding. Provides smooth, rounded surface and corners design.

No metal parts on the door.

Tie wing area satisfies different traction and ligation.

Low profile design. Improves the comfort of the patients.

Reliable bonding base design. Enhances the strength of the bond.

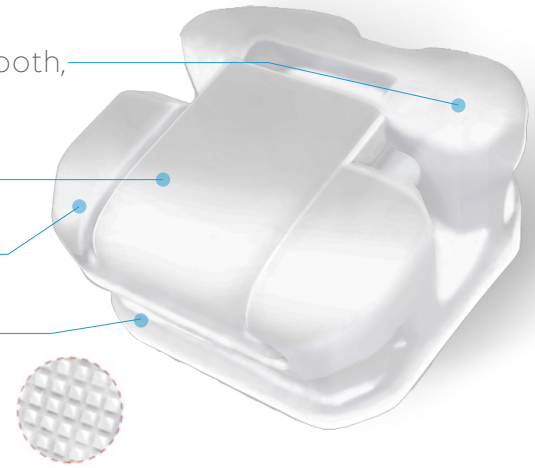

FULL SET			
Ceramic Self Ligating Brackets	TYPE	0.018 SLOT	0.022 SLOT
	Upper & Lower without Hook	-	OR-VC-201A
	Upper & Lower with Hook on 3	-	OR-VC-201B
	Upper & Lower with Hook on 3, 4 & 5	-	OR-VC-201C

CERAMIC SELF LIGATING									
MAXILLARY	Tooth	Torq.	Ang.	M/D Width	Hook	.018 Slot		0.022 Slot	
						RIGHT	LEFT	RIGHT	LEFT
						Central	+12°	+5°	3.1
Lateral	+5°	+9°	2.8	-	-	-	201-212	201-222	
Cuspid	0°	+5°	3.1	-	-	-	201-213	201-223	
1st Bicuspid	-7°	+2°	2.9	-	-	-	201-214	201-224	
2nd Bicuspid	-7°	+2°	2.9	-	-	-	201-215	201-225	
MANDIBULAR	Central	-1°	0°	2.8	-	-	-	201-241	201-231
	Lateral	-1°	0°	2.8	-	-	-	201-242	201-232
	Cuspid	-6°	+3°	3.0	-	-	-	201-243	201-233
	-	-	-	-	-	-	-	-	-
	-	-	-	-	-	-	-	-	-

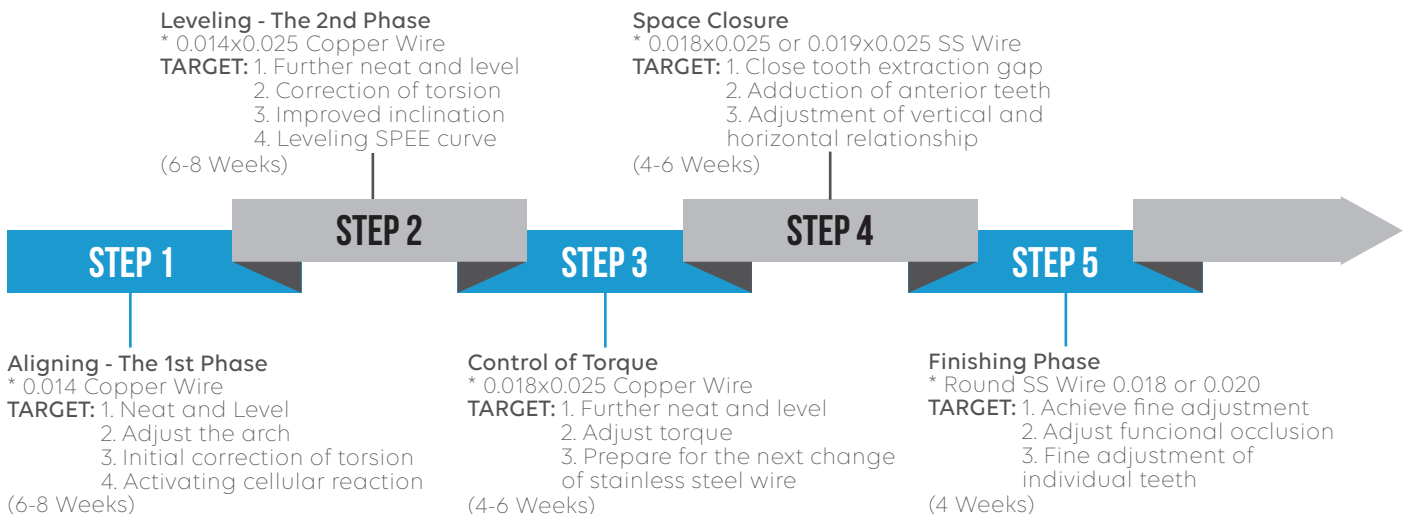



# Buccal Tubes

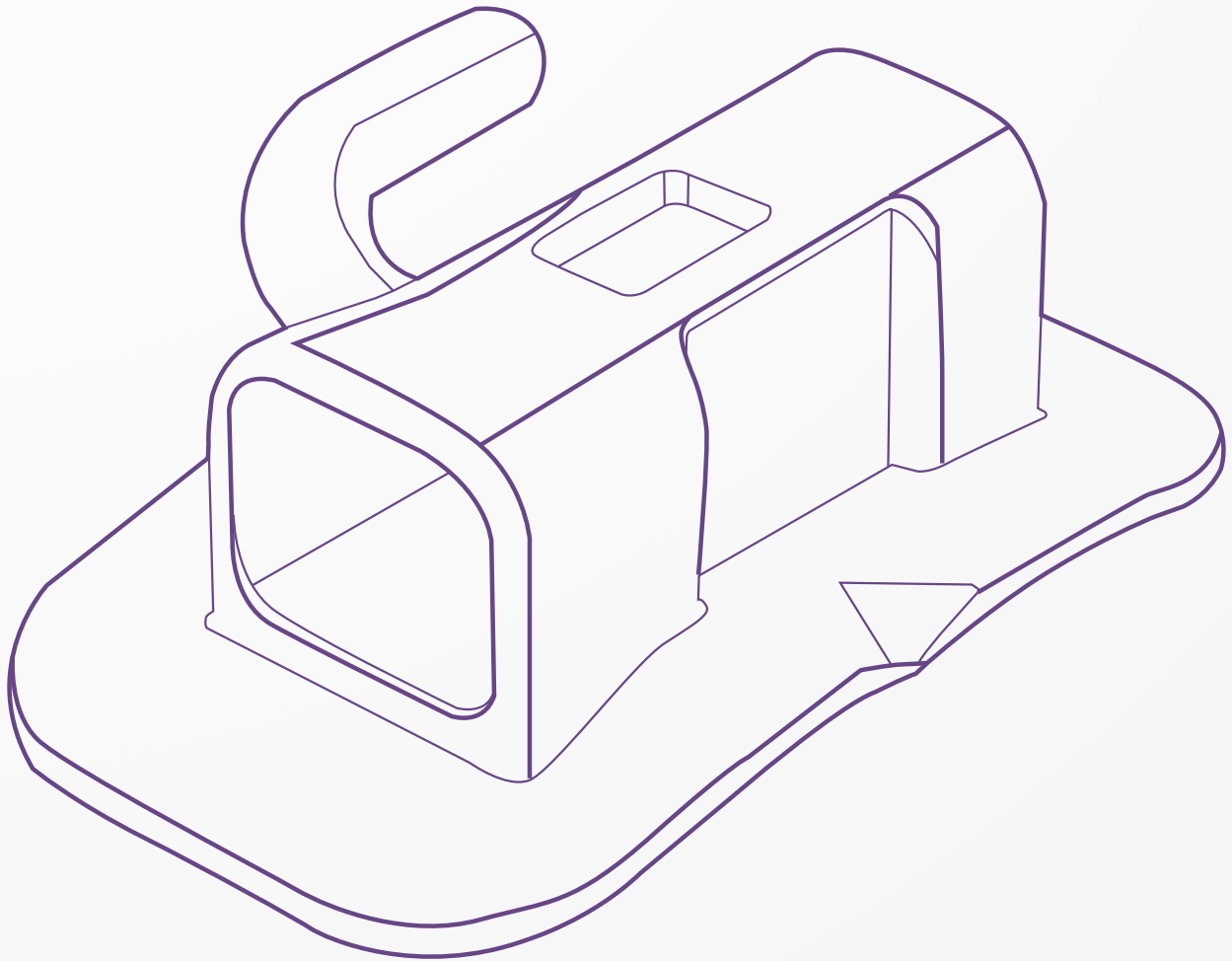

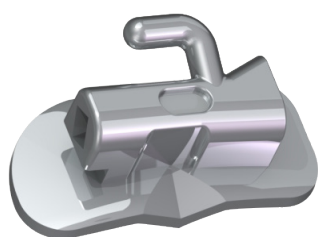

**Non-Convertible Bondable Buccal Tubes**

1ST MOLAR NON-CONVERTIBLE SINGLE BUCCAL TUBES							
Torq.	Distal Offset	Length (mm)	UPPER/LOWER	.018 Slot		0.022 Slot	
				RIGHT	LEFT	RIGHT	LEFT
-12°	+9°	4.5	UPPER	OR18-201-16	OR18-201-26	OR22-202-16	OR22-202-26
-25°	+4°	4.5	LOWER	OR18-201-46	OR18-201-36	OR22-202-46	OR22-202-36

2ND MOLAR NON-CONVERTIBLE SINGLE BUCCAL TUBES							
Torq.	Distal Offset	Length (mm)	UPPER/LOWER	.018 Slot		0.022 Slot	
				RIGHT	LEFT	RIGHT	LEFT
-10°	+10°	3.2	UPPER	OR18-201-17	OR18-201-27	OR22-202-17	OR22-202-27
-25°	0°	3.2	LOWER	OR18-201-47	OR18-201-37	OR22-202-47	OR22-202-37



**Non-Convertible Bondable Buccal Tubes**

1ST MOLAR NON-CONVERTIBLE SINGLE BUCCAL TUBES							
Torq.	Distal Offset	Length (mm)	R/L	.018 Slot		0.022 Slot	
				BONDABLE	WELDABLE	BONDABLE	WELDABLE
-14°	14°	4	UR	OR18-001-16	OR18-002-16	OR22-001-16	OR22-002-16
			UL	OR18-001-26	OR18-002-26	OR22-001-26	OR22-002-26
-10°	14°	4	LR	OR18-001-46	OR18-002-46	OR22-001-46	OR22-002-46
			LL	OR18-001-36	OR18-002-36	OR22-001-36	OR22-002-36

2ND MOLAR NON-CONVERTIBLE SINGLE BUCCAL TUBES							
Torq.	Distal Offset	Length (mm)	R/L	.018 Slot		0.022 Slot	
				BONDABLE	WELDABLE	BONDABLE	WELDABLE
-14°	14°	4	UR	OR18-001-17	OR18-002-17	OR22-001-17	OR22-002-17
			UL	OR18-001-27	OR18-002-27	OR22-001-27	OR22-002-27
-10°	14°	4	LR	OR18-001-47	OR18-002-47	OR22-001-47	OR22-002-47
			LL	OR18-001-37	OR18-002-37	OR22-001-37	OR22-002-37

# Adhesives

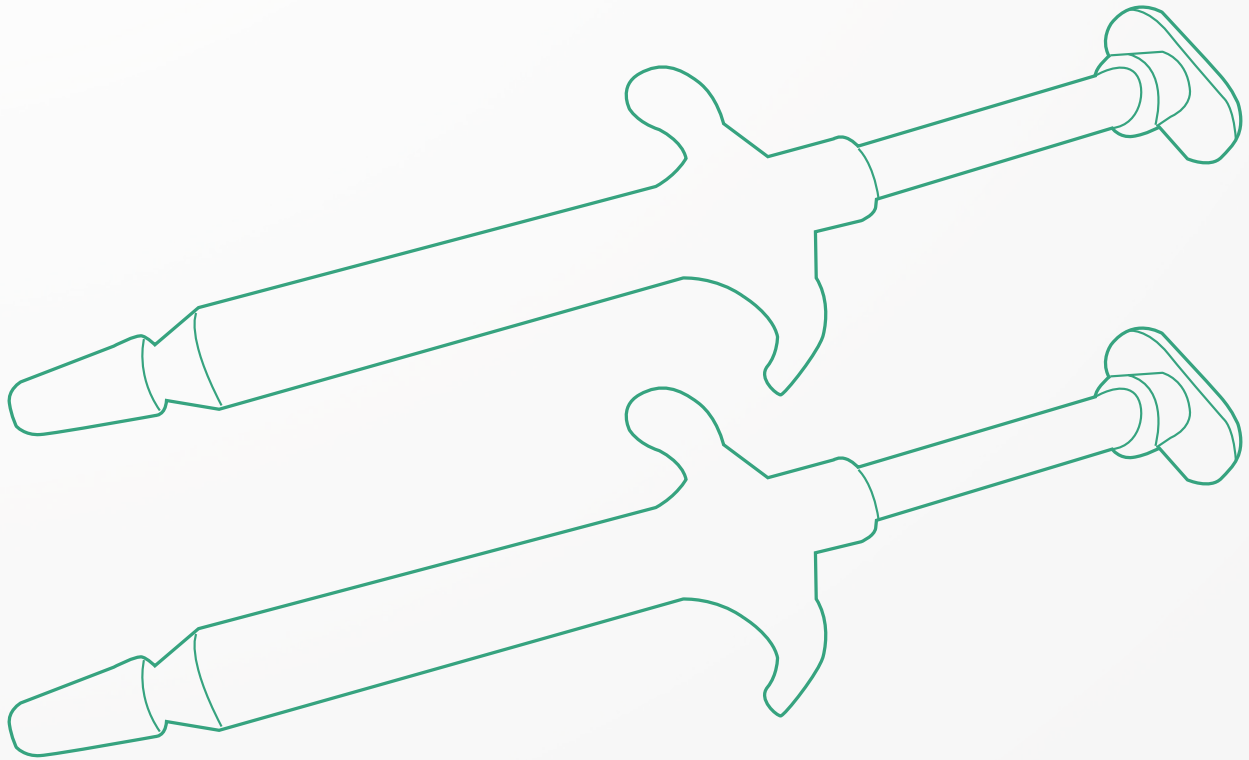

### EasyGlue Light Cure Adhesive

- Used for metal and ceramic orthodontic brackets
- The viscosity of EasyGlue Light Cure Adhesive was designed to prevent adhesive dripping, thus saving financially and reducing adhesive waste.
- EasyGlue Light Cure Adhesive are available in 2 Packing choices



### Orthodontic Light Cure Adhesive

EasyGlue Light Cure Adhesive (Type 1)	
CODE	Description
OR-ALC21	2 EasyGlue Light Cure Adhesive Syringe 3.5g (total 7g)
	1 EasyGlue Light Cure Adhesive PRIMER 8ml
	20 Applicator Brush
	1 Spatula



EasyGlue Light Cure Adhesive (Type 2)	
CODE	Description
OR-ALC11	1 EasyGlue Light Cure Adhesive Syringe 3.5g
	1 EasyGlue Light Cure Adhesive PRIMER 3ml
	20 Applicator Brush
	1 Spatula



### EasyGlue Color Changing Adhesive

- Used for metal and ceramic orthodontic brackets
- Color Changing properties is for easy bracket positioning and easy clean up.
- EasyGlue Color Changing Adhesive are available in 2 Packing choices

### Color Changing Light Cure Adhesive

EasyGlue Light Cure Color Changing Adhesive KIT (Type 1)	
CODE	Description
OR-AGG21	2 EasyGlue Light Cure Adhesive Syringe 4g (total 8g)
	1 EasyGlue Light Cure Adhesive PRIMER 8ml
	20 Applicator Brush
	2 Spatula



EasyGlue Light Cure Color Changing Adhesive KIT (Type 2)	
CODE	Description
OR-AGG11	1 EasyGlue Light Cure Adhesive Syringe 4g
	1 EasyGlue Light Cure Adhesive PRIMER 3ml
	20 Applicator Brush
	1 Spatula



# Wires

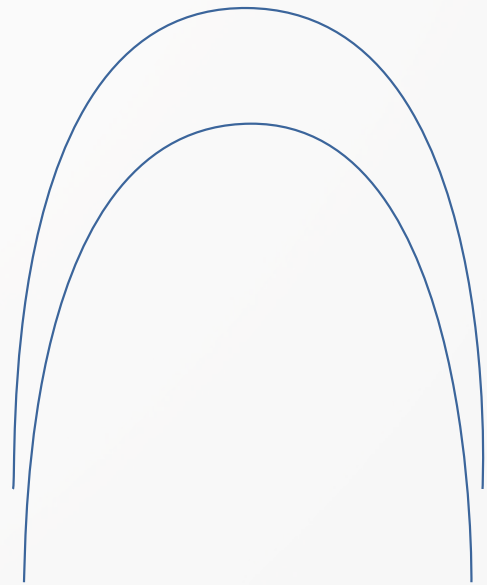
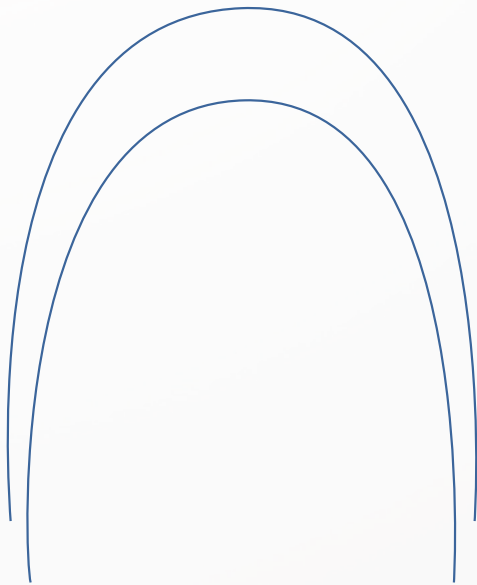

- NiTi Archwires
- Stainless Steel Archwires
- Thermal NiTi Archwires
- Coated Archwires - NiTi and Stainless Steel
- Beta Titanium Archwires
- Copper NiTi Archwires
- NiTi Reverse Curve of Spee

## Arch Forms

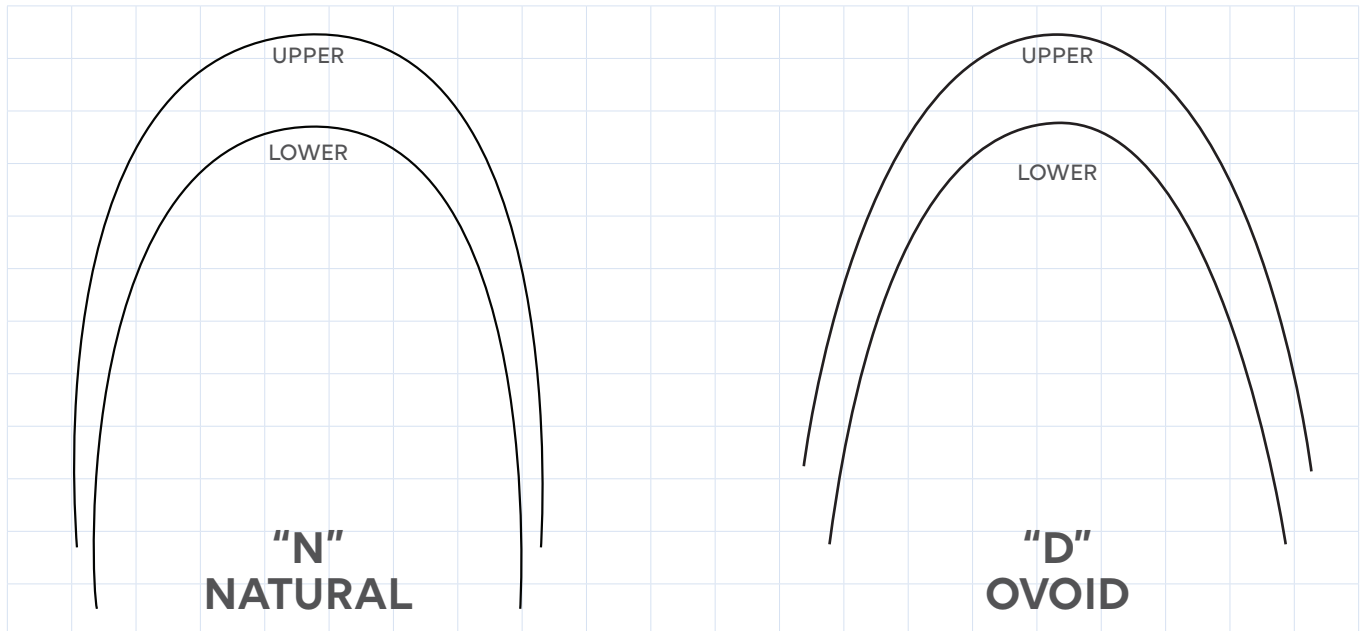

- Used throughout treatment for a wide variety of archwires progressions to simplify adjustment while maintaining ideal arch form
- Used with pre-adjusted appliances with built-in in/out relationships
- Final Phase: Slightly expanded nature is designed to account for natural settling after removal where tendency toward narrowing occurs

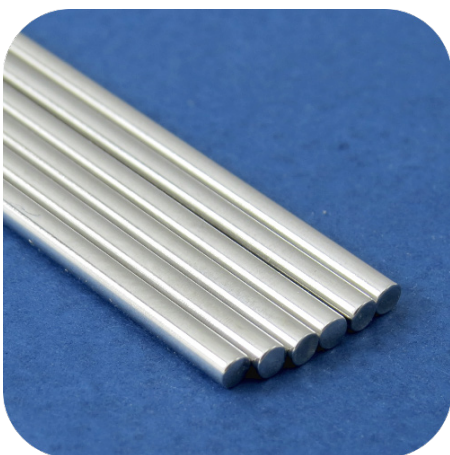

## Archwires

- The wires are manufactured to the highest quality for dimensional precision and surface finish, providing optimum forces for arch stability, resilience, formability and sliding mechanics.
- Our wires offer a full line of Archwires solutions. Natural Form and Ovoid Form are available in Nickel Titanium, Stainless Steel, Thermal NiTi, Coated NiTi and SS, Beta Titanium (TMA), Copper NiTi. NiTi is also available in Reverse Curve of Spee.



## NiTi Archwire

Round	Natural		Ovoid	
	Upper	Lower	Upper	Lower
	10 per PKG	10 per PKG	10 per PKG	10 per PKG
.012	OR-102N	OR-112N	OR-102D	OR-112D
.014	OR-104N	OR-114N	OR-104D	OR-114D
.016	OR-106N	OR-116N	OR-106D	OR-116D
.018	OR-108N	OR-118N	OR-108D	OR-118D
.020	OR-110N	OR-120N	OR-110D	OR-120D

Rectangular	Natural		Ovoid	
	Upper	Lower	Upper	Lower
	10 per PKG	10 per PKG	10 per PKG	10 per PKG
.016x.016	OR-131N	OR-141N	OR-131D	OR-141D
.016x.022	OR-132N	OR-142N	OR-132D	OR-142D
.017x.025	OR-133N	OR-143N	OR-133D	OR-143D
.018x.025	OR-134N	OR-144N	OR-134D	OR-144D
.019x.025	OR-135N	OR-145N	OR-135D	OR-145D
.020x.020	OR-136N	OR-146N	OR-136D	OR-146D
.021x.025	OR-137N	OR-147N	OR-137D	OR-147D



## Stainless Steel

Round	Natural		Ovoid	
	Upper	Lower	Upper	Lower
	25 per PKG	25 per PKG	25 per PKG	25 per PKG
.012	OR-202N	OR-212N	OR-202D	OR-212D
.014	OR-204N	OR-214N	OR-204D	OR-214D
.016	OR-206N	OR-216N	OR-206D	OR-216D
.018	OR-208N	OR-218N	OR-208D	OR-218D
.020	OR-210N	OR-220N	OR-210D	OR-220D

Rectangular	Natural		Ovoid	
	Upper	Lower	Upper	Lower
	10 per PKG	10 per PKG	10 per PKG	10 per PKG
.016x.016	OR-231N	OR-241N	OR-231D	OR-241D
.016x.022	OR-232N	OR-242N	OR-232D	OR-242D
.017x.025	OR-233N	OR-243N	OR-233D	OR-243D
.018x.025	OR-234N	OR-244N	OR-234N	OR-244D
.019x.025	OR-235N	OR-245N	OR-235D	OR-245D
.020x.020	OR-236N	OR-245N	OR-236D	OR-245D
.021x.025	OR-237N	OR-247N	OR-237N	OR-247D



**S** ADD S to part number for 25 PCS per PKG option (25 PCS per PKG option is only available in Rect. SS wires)

## Thermal NiTi Archwires

Round	Natural		Ovoid	
	Upper	Lower	Upper	Lower
	10 per PKG	10 per PKG	10 per PKG	10 per PKG
.012	OR-302N	OR-312N	OR-302D	OR-312D
.014	OR-304N	OR-314N	OR-304D	OR-314D
.016	OR-306N	OR-316N	OR-306D	OR-316D
.018	OR-308N	OR-318N	OR-308D	OR-318D
.020	OR-310N	OR-320N	OR-310D	OR-320D

Rectangular	Natural		Ovoid	
	Upper	Lower	Upper	Lower
	10 per PKG	10 per PKG	10 per PKG	10 per PKG
.016x.016	OR-331N	OR-341N	OR-331D	OR-341D
.016x.022	OR-332N	OR-342N	OR-332D	OR-342D
.017x.025	OR-333N	OR-343N	OR-333D	OR-343D
.018x.025	OR-334N	OR-344N	OR-334D	OR-344D
.019x.025	OR-335N	OR-345N	OR-335D	OR-345D
.020x.020	OR-336N	OR-346N	OR-336D	OR-346D
.021x.025	OR-337N	OR-347N	OR-337D	OR-347D



## Coated NiTi

Round	Natural		Ovoid	
	Upper	Lower	Upper	Lower
	10 per PKG	10 per PKG	10 per PKG	10 per PKG
.012	OR-402N	OR-412N	OR-402D	OR-412D
.014	OR-404N	OR-414N	OR-404D	OR-414D
.016	OR-406N	OR-416N	OR-406D	OR-416D
.018	OR-408N	OR-418N	OR-408D	OR-418D
.020	OR-410N	OR-420N	OR-410D	OR-420D

Rectangular	Natural		Ovoid	
	Upper	Lower	Upper	Lower
	10 per PKG	10 per PKG	10 per PKG	10 per PKG
.016x.016	OR-431N	OR-441N	OR-431D	OR-441D
.016x.022	OR-432N	OR-442N	OR-432D	OR-442D
.017x.025	OR-433N	OR-443N	OR-433D	OR-443D
.018x.025	OR-434N	OR-444N	OR-434D	OR-444D
.019x.025	OR-435N	OR-445N	OR-435D	OR-445D
.020x.020	OR-436N	OR-446N	OR-436D	OR-446D
.021x.025	OR-437N	OR-447N	OR-437D	OR-447D



## Coated Stainless Steel

Round	Natural		Ovoid	
	Upper	Lower	Upper	Lower
	10 per PKG	10 per PKG	10 per PKG	10 per PKG
.012	OR-452N	OR-462N	OR-452D	OR-462D
.014	OR-454N	OR-464N	OR-454D	OR-464D
.016	OR-456N	OR-466N	OR-456D	OR-466D
.018	OR-458N	OR-468N	OR-458D	OR-468D
.020	OR-450N	OR-460N	OR-450D	OR-460D

Rectangular	Natural		Ovoid	
	Upper	Lower	Upper	Lower
	10 per PKG	10 per PKG	10 per PKG	10 per PKG
.016x.016	OR-471N	OR-481N	OR-471D	OR-481D
.016x.022	OR-472N	OR-482N	OR-472D	OR-482D
.017x.025	OR-473N	OR-483N	OR-473D	OR-483D
.018x.025	OR-474N	OR-484N	OR-474D	OR-484D
.019x.025	OR-475N	OR-485N	OR-475D	OR-485D
.020x.020	OR-476N	OR-486N	OR-476D	OR-486D
.021x.025	OR-477N	OR-487N	OR-477D	OR-487D



## Beta Titanium Archwires

Round	Natural		Ovoid	
	Upper	Lower	Upper	Lower
	10 per PKG	10 per PKG	10 per PKG	10 per PKG
.012	OR-502N	OR-512N	OR-502D	OR-512D
.014	OR-504N	OR-514N	OR-504D	OR-514D
.016	OR-506N	OR-516N	OR-506D	OR-516D
.018	OR-508N	OR-518N	OR-508D	OR-518D
.020	OR-510N	OR-520N	OR-510D	OR-520D

Rectangular	Natural		Ovoid	
	Upper	Lower	Upper	Lower
	10 per PKG	10 per PKG	10 per PKG	10 per PKG
.016x.016	OR-531N	OR-541N	OR-531D	OR-541D
.016x.022	OR-532N	OR-542N	OR-532D	OR-542D
.017x.025	OR-533N	OR-543N	OR-533D	OR-543D
.018x.025	OR-534N	OR-544N	OR-534D	OR-544D
.019x.025	OR-535N	OR-545N	OR-535D	OR-545D
.020x.020	OR-536N	OR-546N	OR-536D	OR-546D
.021x.025	OR-537N	OR-547N	OR-537D	OR-547D



## ► Copper NiTi Archwires

● Round	Natural		Ovoid	
	Upper	Lower	Upper	Lower
	10 per PKG	10 per PKG	10 per PKG	10 per PKG
.012	OR-602N	OR-612N	OR-602D	OR-612D
.014	OR-604N	OR-614N	OR-604D	OR-614D
.016	OR-606N	OR-616N	OR-606D	OR-616D
.018	OR-608N	OR-618N	OR-608D	OR-618D
.020	OR-610N	OR-620N	OR-610D	OR-620D

■ Rectangular	Natural		Ovoid	
	Upper	Lower	Upper	Lower
	10 per PKG	10 per PKG	10 per PKG	10 per PKG
.014x.025	OR-630N	OR-640N	OR-630D	OR-640D
.016x.016	OR-631N	OR-641N	OR-631D	OR-641D
.016x.022	OR-632N	OR-642N	OR-632D	OR-642D
.017x.025	OR-633N	OR-643N	OR-633D	OR-643D
.018x.025	OR-634N	OR-644N	OR-634D	OR-644D
.019x.025	OR-635N	OR-645N	OR-635D	OR-645D
.020x.020	OR-636N	OR-646N	OR-636D	OR-646D
.021x.025	OR-637N	OR-647N	OR-637D	OR-647D

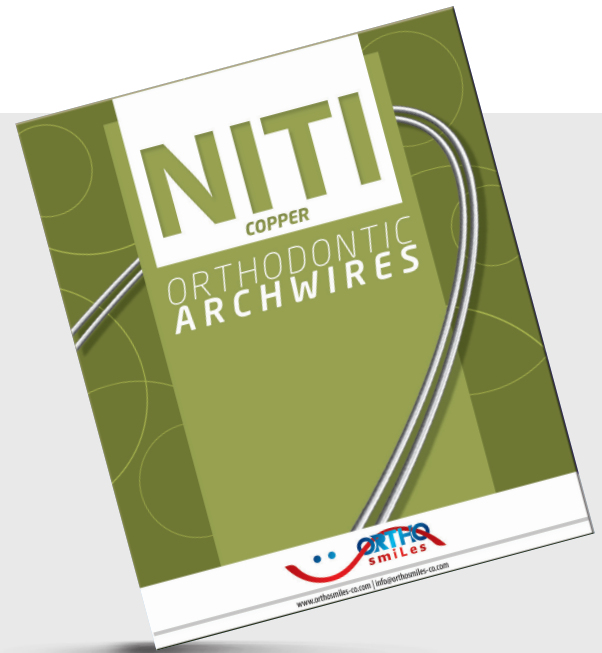

## ► NiTi Reverse Curve of Spee

● Round	Reverse Curve of Spee	
	Upper	Lower
	5 per PKG	5 per PKG
.014	OR-704R	OR-714R
.016	OR-706R	OR-716R
.018	OR-708R	OR-718R

■ Rectangular	Reverse Curve of Spee	
	Upper	Lower
	5 per PKG	5 per PKG
.016x.022	OR-732R	OR-742R
.017x.025	OR-733R	OR-743R
.019x.025	OR-735R	OR-745R





# Elastomerics

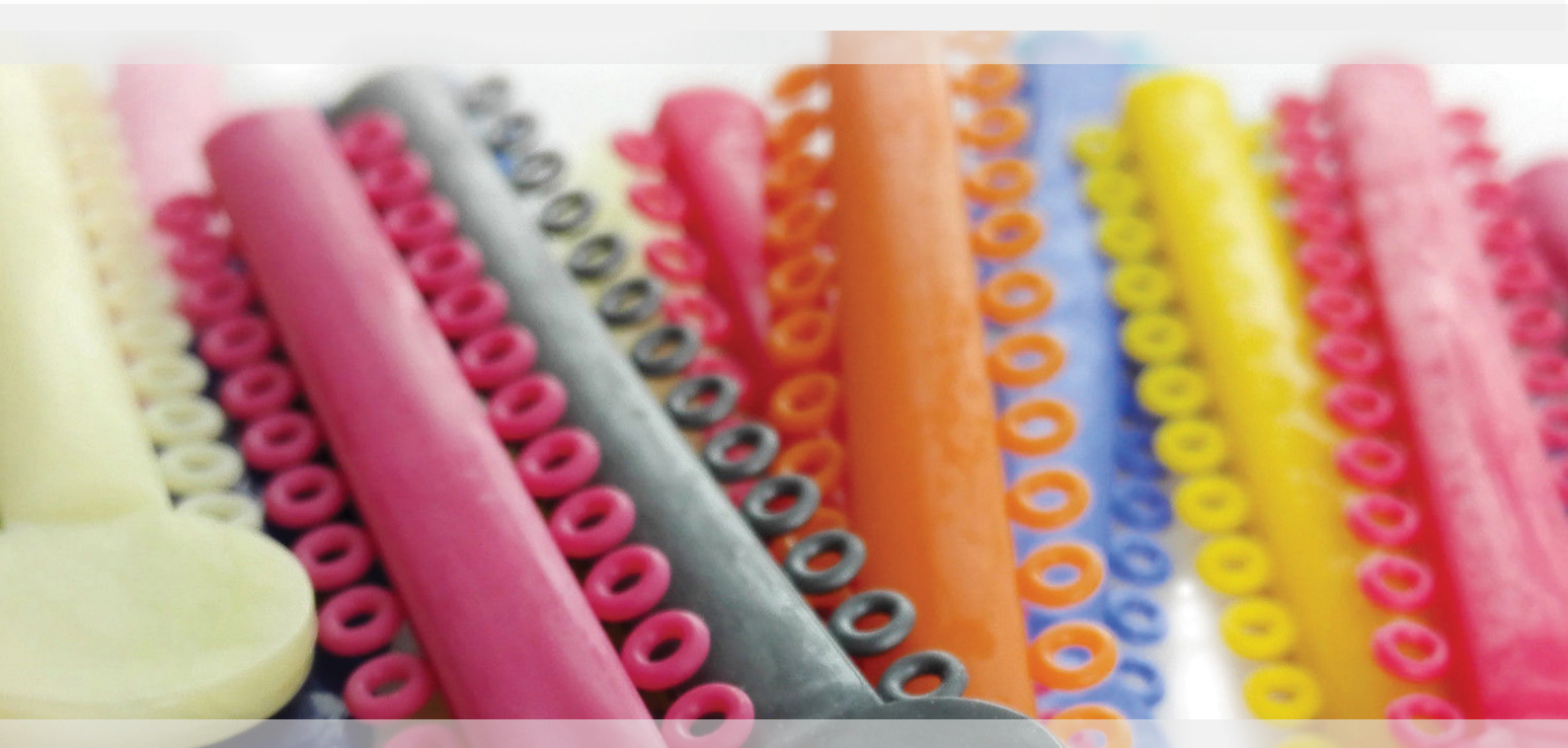

- Ligature Ties
- Chain Elastics
- Intra Oral Elastics
- Separators and Dispensers



## ► Ligature Ties

- 40 Sticks per PKG
- 26 Ligatures per Stick (Total 1040 Ligatures per PKG)

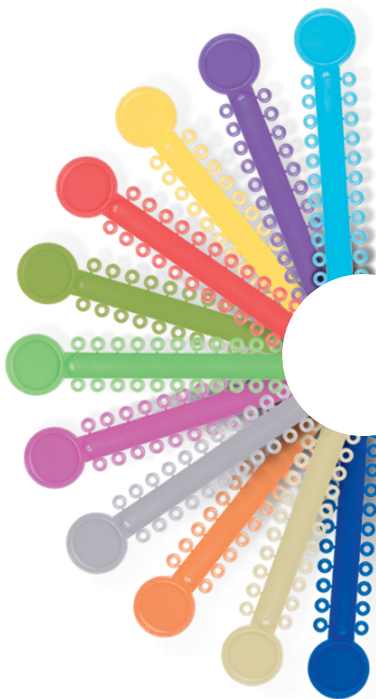

Color	Code	Color	Code	Color	Code
	Magenta <b>OR-01</b>		Crystal Blue <b>OR-18</b>		Green Pearl <b>OR-35</b>
	Deep Red <b>OR-02</b>		Black <b>OR-19</b>		Grassgreen Pearl <b>OR-36</b>
	Red <b>OR-03</b>		Deep Met. Blue <b>OR-20</b>		Red Pearl <b>OR-37</b>
	Autumn Orange <b>OR-04</b>		Blue <b>OR-21</b>		Cyan Pearl <b>OR-38</b>
	Orange <b>OR-05</b>		Gem Blue <b>OR-22</b>		
	Silver Gray <b>OR-06</b>		Deep Met. Purple <b>OR-23</b>		
	Pink <b>OR-07</b>		Crystal Purple <b>OR-24</b>		
	Deep Pink <b>OR-08</b>		White <b>OR-25</b>		
	Baby Pink <b>OR-09</b>		Yellow <b>OR-26</b>		
	Neon Purple <b>OR-10</b>		Clear <b>OR-27</b>		
	Purple <b>OR-11</b>		Lake Blue <b>OR-28</b>		
	Gold <b>OR-12</b>		Sky Blue <b>OR-30</b>		
	Neon Green <b>OR-14</b>		Desert Blue <b>OR-31</b>		
	Green <b>OR-15</b>		Cyan <b>OR-32</b>		
	Grape <b>OR-16</b>		Crystal Yellow <b>OR-33</b>		
	Baby Blue <b>OR-17</b>		Light Purple <b>OR-34</b>		



### Unicycle Dispenser

#### **OR-1014UD**

Holds 180 Sticks of Ligatures

(LIGATURES NOT INCLUDED)  
Made from High Quality Acrylic



# Chain Elastics

- Available in Long, Short and Closed.
- 15ft per Spool



Color	Closed	Short	Long	Color	Closed	Short	Long
Magenta	ORC-01	ORS-01	ORN-01	Blue	ORC-21	ORS-21	ORN-21
Deep Red	ORC-02	ORS-02	ORN-02	Gem Blue	ORC-22	ORS-22	ORN-22
Red	ORC-03	ORS-03	ORN-03	White	ORC-25	ORS-25	ORN-25
Autumn Orange	ORC-04	ORS-04	ORN-04	Yellow	ORC-26	ORS-26	ORN-26
Orange	ORC-05	ORS-05	ORN-05	Clear	ORC-27	ORS-27	ORN-27
Silver Gray	ORC-06	ORS-06	ORN-06	Lake Blue	ORC-28	ORS-28	ORN-28
Pink	ORC-07	ORS-07	ORN-07	Sky Blue	ORC-30	ORS-30	ORN-30
Deep Pink	ORC-08	ORS-08	ORN-08	Desert Blue	ORC-31	ORS-31	ORN-31
Baby Pink	ORC-09	ORS-09	ORN-09	Cyan	ORC-32	ORS-32	ORN-32
Neon Purple	ORC-10	ORS-10	ORN-10	Light Purple	ORC-34	ORS-34	ORN-34
Purple	ORC-11	ORS-11	ORN-11				
Neon Green	ORC-14	ORS-14	ORN-14				
Green	ORC-15	ORS-15	ORN-15				
Grape	ORC-16	ORS-16	ORN-16				
Black	ORC-19	ORS-19	ORN-19				
Deep Met. Blue	ORC-20	ORS-20	ORN-20				

## Orthosmiles Chains

- Offering a consisted force in closed, short or long elastic chains.
- Chain colors are matched with the ligatures available with OrthoSmiles Orthodontics

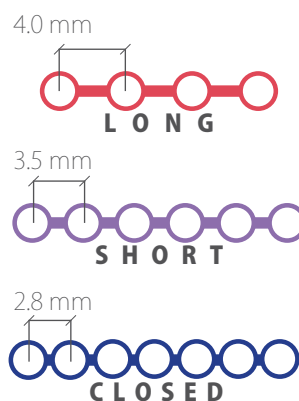













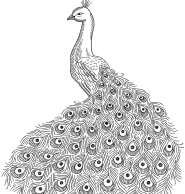

### Chain Elastic Dispenser

#### OR-1016CD

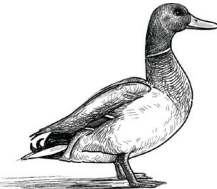
Holds 18 Spools of elastic Chain

(CHAINS NOT INCLUDED)  
Made from High Quality Acrylic

# Intraoral Elastics

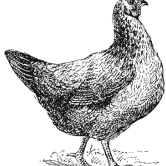
	<b>LIGHT</b> 2.50 oz/70 gms	<b>MEDIUM</b> 4.50 oz/125 gms	<b>HEAVY</b> 6.50 oz/184 gms	<b>EXTRA HEAVY</b> 8 oz/225 gms	<b>MAXIMUM</b> 14 oz/400 gms
1/8" 3.2 mm	<b>DOVE</b>  <b>ORL-201</b>	<b>CANARY</b>  <b>ORL-210</b>	<b>PENGUIN</b>  <b>ORL-220</b>		
3/16" 4.6 mm	<b>HOOPOE</b>  <b>ORL-202</b>	<b>PARROT</b>  <b>ORL-211</b>	<b>SHAHEEN</b>  <b>ORL-221</b>	<b>TOUCAN</b>  <b>ORL-231</b>	
1/4" 6.4 mm	<b>PEACOCK</b>  <b>ORL-203</b>	<b>OWL</b>  <b>ORL-212</b>	<b>FALCON</b>  <b>ORL-222</b>		
5/16" 7.9 mm	<b>DUCK</b>  <b>ORL-204</b>	<b>SWAN</b>  <b>ORL-213</b>	<b>OSTRICH</b>  <b>ORL-223</b>	<b>FLAMINGO</b>  <b>ORL-233</b>	<b>KINGFISHER</b>  <b>ORL-243</b>
3/8" 9.5 mm	<b>CROW</b>  <b>ORL-205</b>	<b>GOOSE</b>  <b>ORL-214</b>	<b>HEN</b>  <b>ORL-224</b>		

**Normal Box**  
**Light/Medium/Heavy**  
 Approx. 5,000 total elastics - 50 patient packs per box (100 elastics per pack)  
**Extra Heavy**  
 Approx. 1,250 total elastics - 25 patient packs per box (100 elastics per pack)  
**Maximum**  
 Approx. 625 total elastics - 25 patient packs per box (50 elastics per pack)

**Small Box**  
**Light/Medium/Heavy**  
 Approx. 2,500 total elastics - 50 patient packs per box (50 elastics per pack)



ADD "S" IN THE CODE FOR SMALL BOX OPTION



NORMAL PACKAGING

Please Note: Elastics are non-returnable items

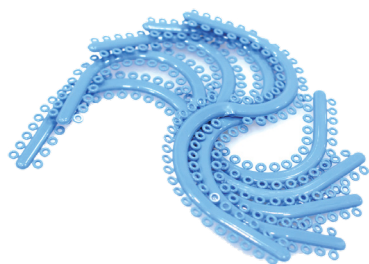

S Type Elastic Separators

**OR-ES250**  
70 PCS per STICK  
15 Sticks per PKG (1,050 PCS Separators)



Radio-Opaque Blue Separators

**OR-RS250**  
100 PCS per PKG



Multi Colored Elastic Placers

**EP2004-A**  
100 PCS per PKG



Lip Bumper Tubing

**OR-460202**  
Gray  
**OR-460206**  
Clear  
10 feet per Spool



Chain Elastic Dispenser

**OR-1016CD**  
Holds 18 Spools of elastic Chain

(CHAINS NOT INCLUDED)  
Made from High Quality Acrylic



Unicycle Dispenser

**OR-1014UD**  
Holds 180 Sticks of Ligatures

(LIGATURES NOT INCLUDED)  
Made from High Quality Acrylic



Unicycle & Chain Dispenser

**OR-1015UC**  
Holds 180 Sticks of Ligatures  
Holds 18 Spools of elastic Chain

(CHAIN AND LIGATURES NOT INCLUDED)  
Made from High Quality Acrylic

# Bands and Attachments

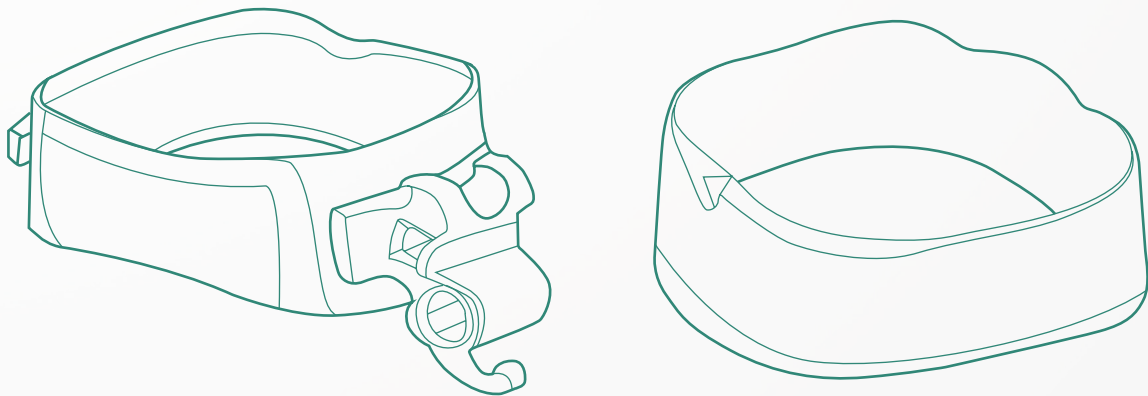

## Plain Molar Bands

- Permanent laser ID marking
- Straight interproximal walls for reduced separation
- Available with micro etched inner surface for increased retention

## 1st/2nd, Bicuspoid Molar Bands

- Permanent laser ID marking
- Straight interproximal walls for reduced separation
- Available with micro etched inner surface for increased retention

## Attachments

- Compatible with the bands we provide
- Available in bondable and weldable types
- High quality precision for accurate weld

PLEASE NOTE: Bands are not returnable items





## 1st Molar Bands (PLAIN)

Plain Molar Bands, does not include any attachment

Size	OR-SHP100	OR-SHP200	OR-SHP400
	Introductory	Professional	Master
30	2	2	4
30+	2	2	4
31	2	2	4
31+	2	4	8
32	2	4	8
32+	2	4	8
33	4	4	8
33+	4	4	8
34	4	6	12
34+	4	6	12
35	4	10	20
35+	4	10	20
36	4	10	20
36+	4	10	20
37	4	14	28
37+	4	14	28
38	4	12	24
38+	6	12	24
39	6	12	24
39+	6	10	20
40	6	10	20
40+	4	10	20
41	4	10	20
41+	4	6	12
42	4	6	12
42+	4	6	12
Total	100	200	400

## BAND KIT DISTRIBUTION

Each kit contains half rights and half lefts



Bands Drawer  
Stackable  
**OR-001B**

Contains 1 PC drawer with  
1 PC white insert



## Bicuspid Bands

Attached with Brackets

Size	OR-SHB100	OR-SHB200	OR-SHB400
	Introductory	Professional	Master
1	1	4	4
2	1	4	4
3	1	4	4
4	1	4	6
5	1	4	6
6	2	4	10
7	2	4	10
8	4	8	18
9	4	8	18
10	4	8	18
11	4	12	18
12	5	16	26
13	5	16	26
14	5	16	26
15	5	16	26
16	5	16	26
17	5	16	26
18	5	16	26
19	5	16	26
20	5	16	26
21	5	16	26
22	5	16	26
23	4	12	18
24	4	8	18
25	4	8	18
26	2	8	10
27	1	4	10
28	1	4	6
29	1	4	6
30	1	4	4
31	1	4	4
32	1	4	4
Total	100	300	500



## 1st Molar Bands with Cleat

Attached with Double Tubes and Lingual Cleat

Size	OR-SHC100	OR-SHC200	OR-SHC400
	Introductory	Professional	Master
30	2	2	4
30+	2	2	4
31	2	2	4
31+	2	4	8
32	2	4	8
32+	2	4	8
33	4	4	8
33+	4	4	8
34	4	6	12
34+	4	6	12
35	4	10	20
35+	4	10	20
36	4	10	20
36+	4	10	20
37	4	14	28
37+	4	14	28
38	4	12	24
38+	6	12	24
39	6	12	24
39+	6	10	20
40	6	10	20
40+	4	10	20
41	4	10	20
41+	4	6	12
42	4	6	12
42+	4	6	12
Total	100	200	400



## 1st Molar Bands with Sheath

Attached with Double Tubes and Lingual Sheath

Size	OR-SHS100	OR-SHS200	OR-SHS400
	Introductory	Professional	Master
30	2	2	4
30+	2	2	4
31	2	2	4
31+	2	4	8
32	2	4	8
32+	2	4	8
33	4	4	8
33+	4	4	8
34	4	6	12
34+	4	6	12
35	4	10	20
35+	4	10	20
36	4	10	20
36+	4	10	20
37	4	14	28
37+	4	14	28
38	4	12	24
38+	6	12	24
39	6	12	24
39+	6	10	20
40	6	10	20
40+	4	10	20
41	4	10	20
41+	4	6	12
42	4	6	12
42+	4	6	12
Total	100	200	400



# Accessories

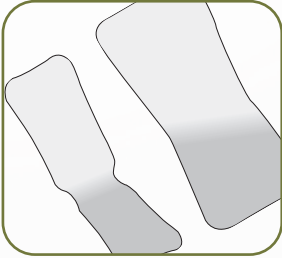

**RELIEF WAX**  
scented colored box



 **Orthosmiles Basics**  
FLAVORED PATIENT WAX



Retainer Boxes



Impression Trays



Dispensers



Cheek Retractors



Ortho Patient Kit



Mirrors



Springs



Buttons



Hooks & Stoppers



Chrome 2000 Retainer Boxes (Small)

**OR-R12ACR**  
2 Assorted Color Each  
W-78mm x H-26mm  
(12 PCS per PKG)



Chrome 2000 Retainer Boxes (Medium)

**OR-R13ACR**  
2 Assorted Color Each  
W-80mm x H-30mm  
(10 PCS per PKG)



Chrome 2000 Retainer Boxes (Large)

**OR-R14ACR**  
2 Assorted Color Each  
W-80mm x H-47mm  
(10 PCS per PKG)



Retainer Boxes (ASST)  
**OR-R12ART**  
2 Assorted Color Each  
(12 PCS per PKG)

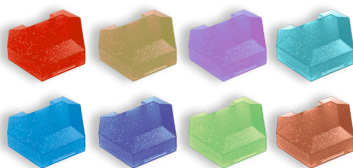

Glitters Retainer Boxes  
**OR-R12AGT**  
2 Assorted Color Each  
(12 PCS per PKG)



Tropical Retainer Boxes  
**OR-R12ATC** Assorted Color  
**OR-R12BTC** Blue Color  
**OR-R12PTC** Amethyst Color  
**OR-R12RTC** Rose Color  
12 pcs per PKG



**RELIEF WAX**  
scented colored box

**OR-OW50A**  
50 PCS Wax per PKG  
(Individually Packed)  
Flavored Wax per BOX



**Orthosmiles Basics**  
FLAVORED PATIENT WAX

**OR-DW50A**  
Contains 50 PCS  
(Individually Packed)  
Flavored Wax per BOX



Alginate Bowl

<b>Medium</b>	<b>Large</b>
<b>OR-MBM4C</b> Emerald Color	<b>OR-MBL4C</b> Emerald Color
<b>OR-MBM3C</b> Citrine Color	<b>OR-MBL3C</b> Citrine Color
<b>OR-MBM2C</b> Sapphire Color	<b>OR-MBL2C</b> Sapphire Color
<b>OR-MBM12C</b> Amber Color	<b>OR-MBL12C</b> Amber Color
<b>OR-MBM10C</b> Amethyst Color	<b>OR-MBL10C</b> Amethyst Color



Alginate Mixing Spatula

<b>OR-SA2C</b> Sapphire Color	<b>OR-SA10C</b> Amethyst Color
<b>OR-SA3C</b> Citrine Color	<b>OR-SA12C</b> Amber Color
<b>OR-SA4C</b> Emerald Color	<b>OR-SA6C</b> Pink Color
<b>OR-SA5C</b> Ruby Color	

# e TRAYS

xcellent-COLOR™

CHILD SIZES

ADULT

<b>OR-ITO1U</b> Small Upper - Red 25 PCS per PKG	<b>OR-ITO1L</b> Small Lower - Red 25 PCS per PKG	<b>OR-ITO4U</b> Small Upper - Green 25 PCS per PKG	<b>OR-ITO4L</b> Small Lower - Green 25 PCS per PKG
<b>OR-ITO2U</b> Medium Upper - Orange 25 PCS per PKG	<b>OR-ITO2L</b> Medium Lower - Orange 25 PCS per PKG	<b>OR-ITO5U</b> Medium Upper - Yellow 25 PCS per PKG	<b>OR-ITO5L</b> Medium Lower - Yellow 25 PCS per PKG
<b>OR-ITO3U</b> Large - Blue 25 PCS per PKG	<b>OR-ITO3L</b> Large Lower - Blue 25 PCS per PKG	<b>OR-ITO6U</b> Large Upper - Purple 25 PCS per PKG	<b>OR-ITO6L</b> Large Lower - Purple 25 PCS per PKG

**ASSORTED OR-ITOAST**

Small Medium Large  
4pcs Each Size  
(48 PCS per PKG)



**Bracket Tray Holder**

**OR-BTH**

Smoke Color  
Can hold 10 Individual Patient Case of Bracket

**Bracket Tray (Disposable)**

**OR-BT001**

White, 25 PCS per PKG  
Sold Separately from the Tray Holder



**Relief Wax Acrylic Dispenser (Holder)**

**OR-1012AW**

Holds 100 PCS of relief wax.

(WAX NOT INCLUDED)  
Made from High Quality Acrylic



**Plier Rack with Cover**

**OR-1010CR**

Holds 13- 15 Ortho Instruments  
(INSTRUMENTS NOT INCLUDED)  
Made from High Quality Acrylic



**Archwire Dispenser**

**OR-1013AC**

Holds any kind of Wires

Made from High Quality Acrylic



**Chain Elastic Dispenser**

**OR-1016CD**

Holds 18 Spools of elastic Chain  
(CHAINS NOT INCLUDED)  
Made from High Quality Acrylic



**Wire Holder Square with Cover**

**OR-YK-10**

Holds Rectangular Wires  
Sizes : 1616/1622/1725/  
1825/1925/1225

L200 x W110 x H99mm  
Made from High Quality Acrylic



**Unicycle Dispenser**

**OR-1014UD**

Holds 180 Sticks of Ligatures  
(LIGATURES NOT INCLUDED)  
Made from High Quality Acrylic



**Wire Holder Round with Cover**

**OR-YK-11**

Holds Round Wires  
Sizes : .012", .013", .014",  
.016", .018", .020"

L200 x W110 x H96mm  
Made from High Quality Acrylic



**Unicycle & Chain Dispenser**

**OR-1015UC**

Holds 180 Sticks of Ligatures  
Holds 18 Spools of elastic Chain  
(CHAINS & LIGATURES NOT INCLUDED)  
Made from High Quality Acrylic



**Wire Holder Round & Square with Cover**

**OR-YK-12**

Holds Round & Rectangular Wires  
Sizes : .012", .014", .016",  
.018" 1622, 1725, 1825, 1925

Made from High Quality Acrylic





Cervical Neck strap with  
Safety Release Spring Module

**OR-208NP**  
Neck Strap Kit



High Pull  
Headgear w/ Safety

**OR-207HG**  
High Pull Headgear Kit



Headgear  
with Chin Cap

**OR-206CH**  
Contains Headgear  
including the chin cap

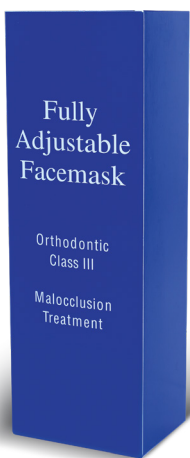

Facemask  
Fully Adjustable

**OR140-05**  
Blue (Type 2)

**OR140-06**  
Lilac (Type 2)

**OR140-07**  
Blue (Type 3)

**OR140-08**  
Red (Type 3)



Cheek Retractor  
with Handles

**OR-1321**  
2 PCS per PKG



Hands-Free  
Cheek Retractor

**OR-CT-A**  
Adult Size (132\*92\*20mm)  
2 PCS per PKG

**OR-CT-M**  
Teen Size (118\*90\*20mm)  
2 PCS per PKG  
**Autoclavable up to 121°C**



"W" Style  
Cheek Retractor

**OR-WT-S**  
Small (100\*44\*44mm)  
2 PCS per PKG

**OR-WT-M**  
Medium (118\*48\*48mm)  
2 PCS per PKG

**OR-WT-L**  
Large (136\*51\*51mm)  
2 PCS per PKG  
**Autoclavable up to 135°C**



Hands-free  
Cheek Retractor

**OR-9000**  
Adult Size  
2 PCS per PKG

**OR-9001**  
Child Size  
2 PCS per PKG

**OR-9001T**  
Teen Size  
2 PCS per PKG



Intraoral  
Cheek Retractor

**OR-9006**

Large Size  
**OR-9007**

Medium Size  
**OR-9008**

Small Size



C Style  
Cheek Retractor

**OR-CD-M**  
2 PCS per PKG (Child)

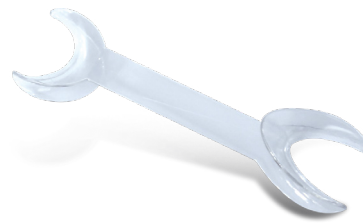

Double Ended  
Cheek Retractor

**OR-9004**  
Large  
2 PCS per PKG

**OR-9005**  
Small  
2 PCS per PKG

**Autoclavable up to 250°C**



Wide Cheek  
Cheek Retractor

**OR-9010**  
Double Ended  
2 PCS per PKG



Photographic  
Lip Retractor

**OR-9020**

Small - 1 PC

**OR-9021**

Large - 1 PC



Double Span  
Cheek Retractor

**OR-SK-A**

Adult (165\*51\*24mm)  
2 PCS per PKG

**OR-SK-C**

Child (147\*42\*19mm)  
2 PCS per PKG

**Autoclavable up to 121°C**



Handhold  
Cheek Retractor

**OR-9002**

Adult Size  
2 PCS per PKG

**OR-9003**

Child Size  
2 PCS per PKG



"T" Style  
Cheek Retractor

**OR-TK-A**

Adult (128\*48\*18cm)  
2 PCS per PKG

**OR-TK-C**

Child (115\*40\*18cm)  
2 PCS per PKG

**Autoclavable**



"O" Style  
Cheek Retractor

**OR-OT-A**

2 PCS per PKG



G1 Intraoral  
Photographic Mirror  
**OR-A1-001**  
Glass Mirror  
Double Side



G4 Intraoral  
Photographic Mirror  
**OR-A4-004**  
Glass Mirror  
Double Side



G2 Intraoral  
Photographic Mirror  
**OR-A2-002**  
Glass Mirror  
Double Side



G5 Intraoral  
Photographic Mirror  
**OR-A5-005**  
Glass Mirror  
Double Side



G3 Intraoral  
Photographic Mirror  
**OR-A3-003**  
Glass Mirror  
Double Side



Intraoral Photographic  
Glass Mirrors SET  
**062888**  
Contains 5 PCS of Mirrors  
G1 - 1PC  
G2 - 1PC  
G3 - 1PC  
G4 - 1PC  
G5 - 1PC

C1 Type Stainless Steel  
Mirror  
**OR-C1-001**

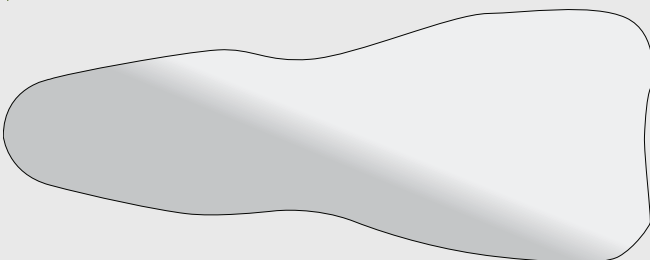

C2 Type Stainless Steel  
Mirror  
**OR-C2-002**

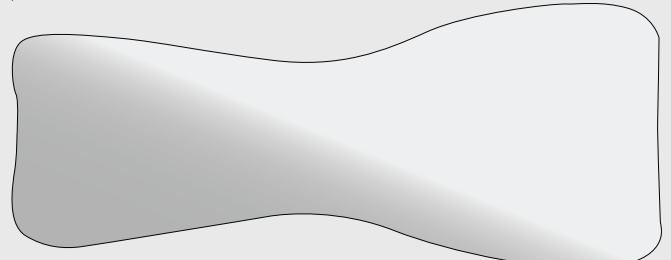



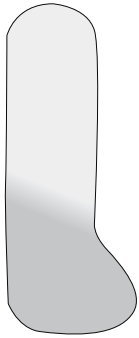

4A Stainless Steel  
Photographic Mirror  
**OR-F4A-003**  
Single Side

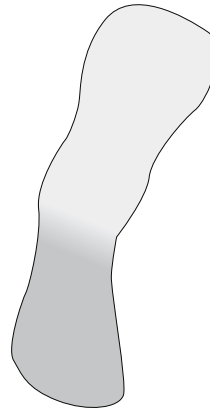

5B Stainless Steel  
Photographic Mirror  
Single Side  
**OR-N5B-002**  
Double Side  
**OR-NS5B-002**

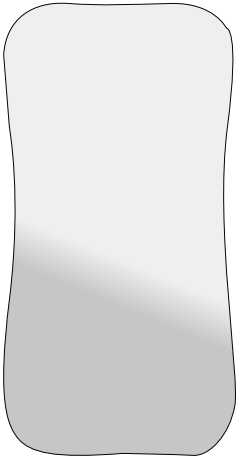

4B Stainless Steel  
Photographic Mirror  
**OR-F4B-003**  
Single Side

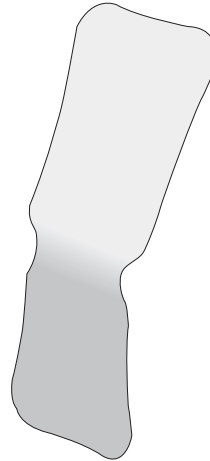

5A Stainless Steel  
Photographic Mirror  
Single Side  
**OR-N5A-001**  
Double Side  
**OR-NS5A-001**

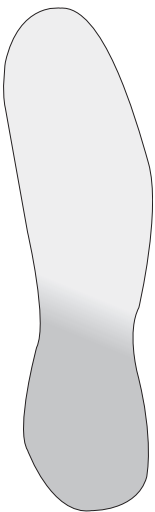

4C Stainless Steel  
Photographic Mirror  
**OR-F4C-003**  
Single Side

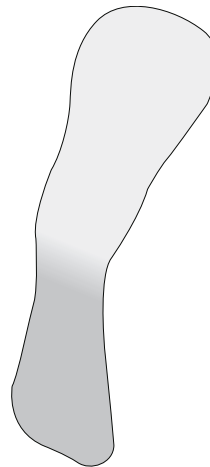

5B Stainless Steel  
Photographic Mirror  
Single Side  
**OR-N5B-004**  
Double Side  
**OR-NS5B-004**

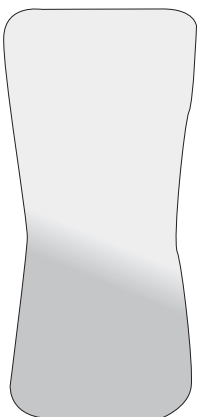

4D Stainless Steel  
Photographic Mirror  
**OR-F4D-003**  
Single Side

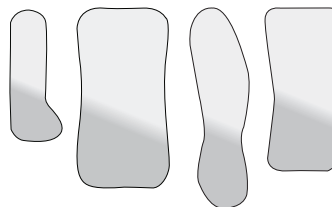

Image  
Reflectors SET (SS)  
**062281**  
Contains 4 PCS of Mirrors  
4A - 1PC  
4B - 1PC  
4C - 1PC  
4D - 1PC



Photo  
Contrast  
**OR-H1-001**  
H1 Big  
**OR-H2-002**  
H2 Small



Lingual Buttons  
Curved

**OR-9131**

Curved  
10 PCS per PKG



Lingual Buttons  
Rectangular

**OR-9132**

Curved  
10 PCS per PKG



Ortho Traction Chain  
(Gold Chain)

**OR-G104**

Round  
5 PCS per PKG



**OR-9134**

with Eyelet  
10 PCS per PKG



Lingual (CERAMIC)  
Buttons

**OR-9133**

10 PCS per PKG

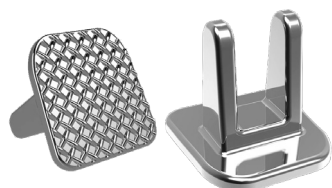

Bondable  
Hinge (Tongue Tamers)

**OR-B124**

10 PCS per PKG



Bite Turbos

**OR-BT125**

10 PCS per PKG



Crimpable Hooks  
Ball Top 2.1mm

**OR-CH221**

Ball Top type  
10 PCS per PKG



Crimpable Hook  
Straight (Long/Short)

**OR-ST302L**

Long - Straight  
10 PCS per PKG

**OR-ST302S**

Short - Straight  
10 PCS per PKG



Crimpable Mini Stop

**OR-CS21**

0.21"x2mm (Max  
Wire - 17x25)  
100 PCS per PKG

**OR-CS27**

0.27"x2mm (Max  
Wire - 21x25)  
100 PCS per PKG

**OR-CS31**

0.31"x2mm  
100 PCS per PKG



Spiral Crimpable  
Hooks

**OR-SC301R**

Right  
10 PCS per PKG

**OR-SC401L**

Left  
10 PCS per PKG



Crimpable Hook  
Long (Left/Right)

**OR-CC302L**

Curved - Left  
10 PCS per PKG

**OR-CC302R**

Curved - Right  
10 PCS per PKG



Crimpable Torquing  
Spring (FREE SIZE)

**OR-F323**

FREE SIZE  
10 PCS per PKG



Torquing  
Spring

**OR-S123**

Small - .019 x .025  
10 PCS per PKG

**OR-L323**

Large - .019 x .025  
10 PCS per PKG

**OR-M231**

Medium SIZE  
10 PCS per PKG



Closed Coil Spring with Eyelet

	LIGHT	MEDIUM	HEAVY
8 mm	OR-13115	OR-13111	OR-13112
13 mm	OR-13116	OR-13114	OR-13113



Ortho Kit LARGE (Soft Case Chrome)

**OR-20209**

Large Chrome - Includes 2 Tooth brush, 1 Floss, 1 Timer, 1 Mirror, 1 Wax, 1 Timer, 1 Small Brush Floss



Ortho Patient Kit (Soft Case)

**OR-20207**

Clear or Blue - Includes 2 Tooth brush, 1 Floss, 1 Timer, 1 Mirror, 1 Wax, 1 Timer, 1 Small Brush Floss



Ortho Patient Kit (Mesh Type)

**OR-20206**

Mesh (Available in a lot of colors) - Includes 2 Tooth brush, 1 Floss, 1 Timer, 1 Mirror, 1 Wax, 1 Timer, 1 Small Brush Floss



Ortho Patient Kit (Hard Case Type)

**OR-20205**

Hard Case (Available in a lot of colors) - Includes 2 Tooth brush, 1 Floss, 1 Timer, 1 Mirror, 1 Wax, 1 Timer, 1 Small Brush Floss

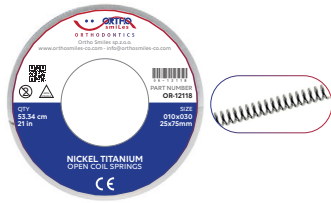

NiTi Open Coil Spring

**OR-12118**  
SPOOL



Stainless Steel Closed Coil Spring

**OR-26121**  
SPOOL



Ligature Wire  
SS SPOOL - 30G

**OR-010-010**  
0.010 - 30G  
**OR-020-020**  
0.020 - 30G  
**OR-025-025**  
0.025 - 30G  
**OR-030-030**  
0.030 - 30G



Impact Resistant  
Protective Glasses

**OR-88602**  
E2 Black with Cover and  
Cleaning Cloth  
**OR-88603**  
E3 Blue with Cover and  
Cleaning Cloth  
**OR-88604**  
E3 Red with Cover and  
Cleaning Cloth



Ligature Wire  
SS SPOOL - 100G

**OR-025-100**  
0.025 - 100G  
**OR-030-100**  
0.030 - 100G



UV Light Block  
Safety Protective Glasses

**OR-62884**  
Black Frame

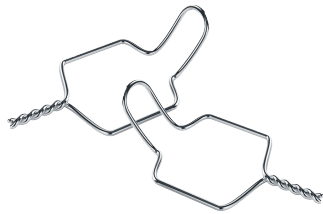

Ligature Wire  
Short Twist

**OR-009-25T**  
Dia. .009 (23mm)  
500 PCS per PKG  
**OR-010-25T**  
Dia. .010 (25mm)  
500 PCS per PKG  
**OR-012-30T**  
Dia. .012 (30mm)  
500 PCS per PKG



Impact Resistant  
Protective Glasses (CLEAR)

**OR-62883**  
Clear Glasses with Blue  
Frame



Preformed Ligature  
Wire

**OR-009-25P**  
Dia. .009 (25mm)  
500 PCS per PKG  
**OR-010-25P**  
Dia. .010 (25mm)  
1000 PCS per PKG  
**OR-012-30P**  
Dia. .012 (30mm)  
1000 PCS per PKG



Kobayashi Hooks  
Preformed/Twist

**OR-K30L**  
Dia. .012 (30mm)  
Long 100 PCS per PKG  
**OR-K35L**  
Dia. .014 (35mm)  
Long 100 PCS per PKG



Color Code Rings  
Autoclavable (Dry Heat)

Medium	Large
<b>OR-CM100</b> White	<b>OR-CL100</b> White
<b>OR-CM101</b> Maive	<b>OR-CL101</b> Maive
<b>OR-CM102</b> Purple	<b>OR-CL102</b> Purple
<b>OR-CM103</b> Blue	<b>OR-CL103</b> Blue
<b>OR-CM104</b> Yellow	<b>OR-CL104</b> Yellow
<b>OR-CM105</b> Green	<b>OR-CL105</b> Green
<b>OR-CM106</b> Red	<b>OR-CL106</b> Red
<b>OR-CM10A</b> Assorted	<b>OR-CL10A</b> Assorted

**OR-K30T**  
Dia. .012 (30mm)  
Twist 100 PCS per PKG  
**OR-K35T**  
Dia. .014 (35mm)  
Twist 100 PCS per PKG

# IPR System

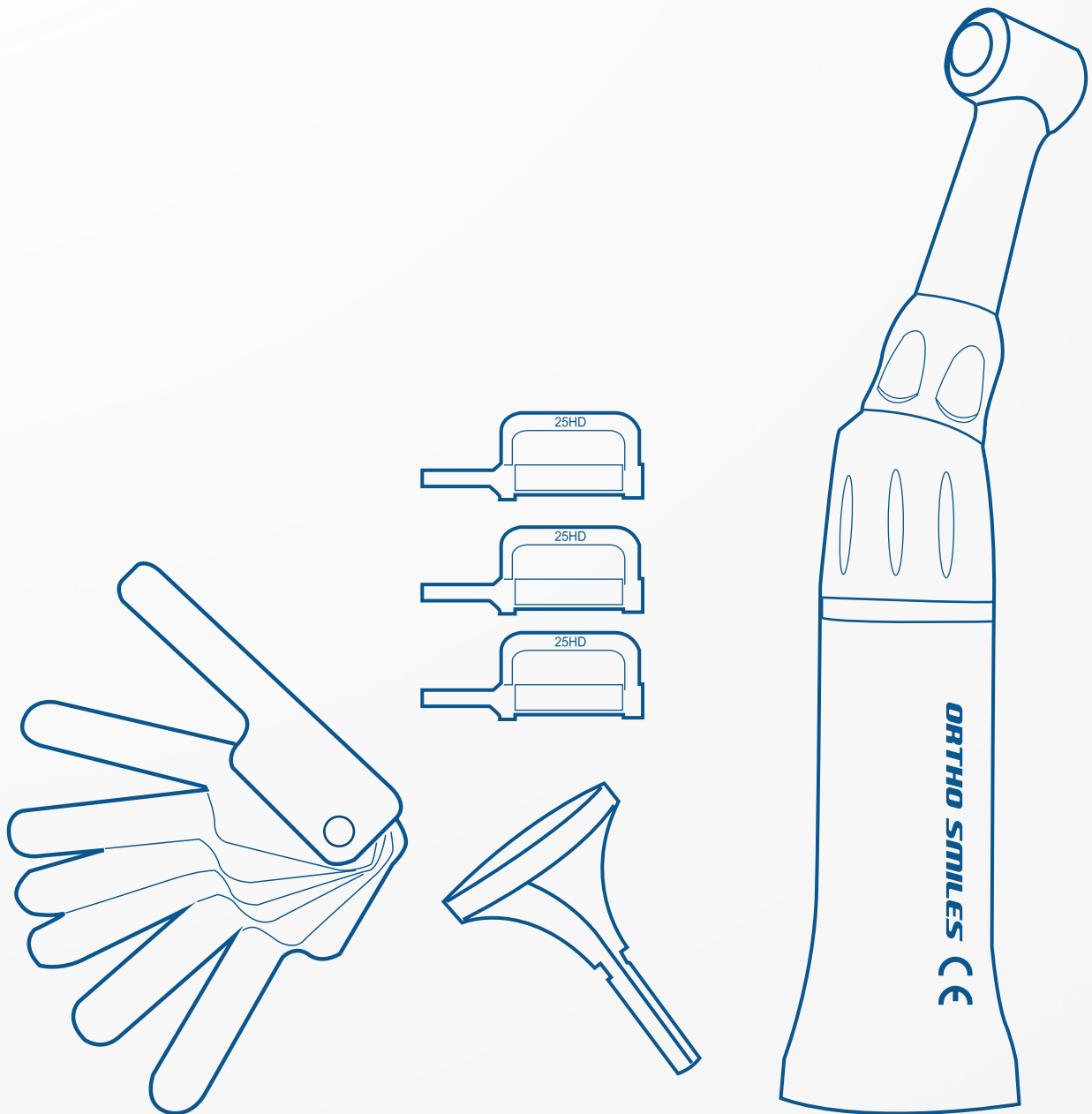



## Features & Benefits



Interproximal reduction (IPR) involves the selective removal of enamel proximally to create space for tooth movement. IPR can be performed in conjunction with traditional orthodontics or clear aligners, with treatment planned by the clinician or, in some cases, through lab services that utilize digital technology. IPR is a safe and effective method to create space for orthodontic tooth movement where mild or moderate crowding exists, particularly useful for treating crowding in the anterior segment (the 'social six') and suitable for recontouring individual teeth.



IPR System KIT (FULL)	
CODE	Description
OR-1600	Reciprocating Contra Angle
	IPR Stripping Handles
	Contra Angle Hand Piece
	IPR Thickness Gauge Set
	Strips 10 PCS





# IPR System (Reorder Components)

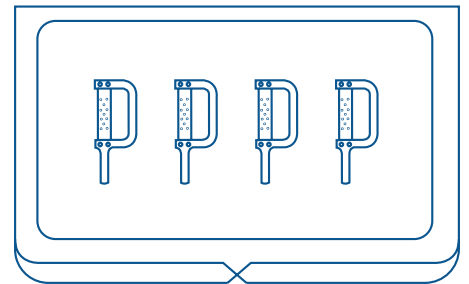
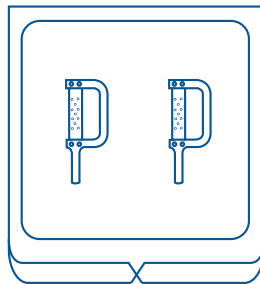
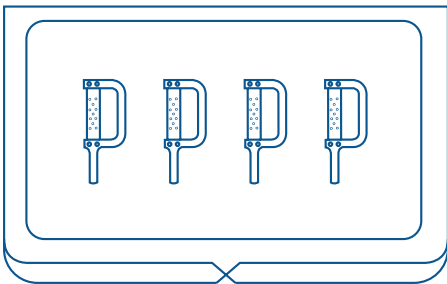
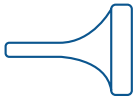
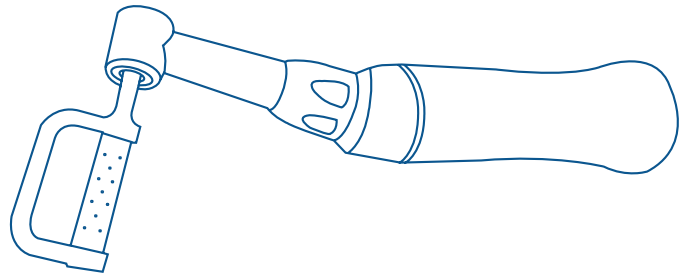
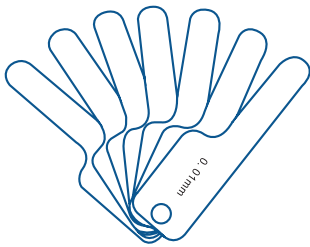
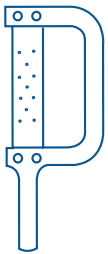

## Features & Benefits



Interproximal reduction (IPR) involves the selective removal of enamel proximally to create space for tooth movement. IPR can be performed in conjunction with traditional orthodontics or clear aligners, with treatment planned by the clinician or, in some cases, through lab services that utilize digital technology. IPR is a safe and effective method to create space for orthodontic tooth movement where mild or moderate crowding exists, particularly useful for treating crowding in the anterior segment (the 'social six') and suitable for recontouring individual teeth.

IPR System (Reorder Components)					
µm	80	60	40	25	15
494			OR-1640		
524	OR-1680			OR-1625	
514		OR-1660			OR-1615
514 514 504	Reduction	Contouring	Contouring	Finishing	Polishing

Reorder Descriptions		
CODE	Description	µm
OR-1680	Extracoarse	80
OR-1680	Coarse	60
OR-1640	Medium	40
OR-1625	Fine	25
OR-1615	Polishing	15

# Multi Anchor System

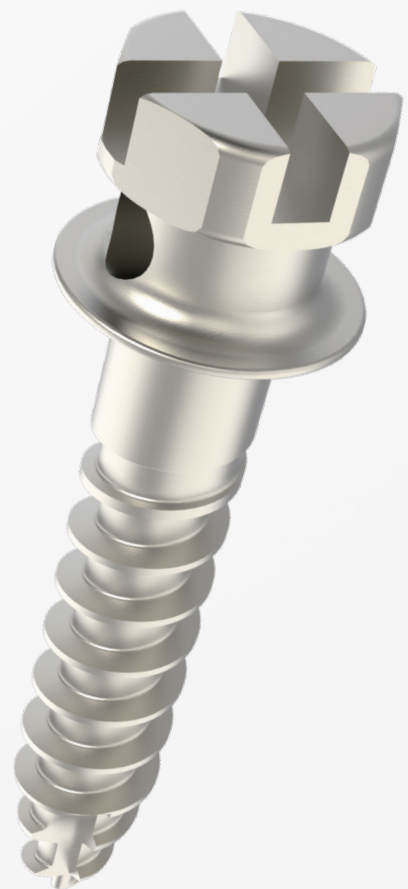

## Features & Benefits

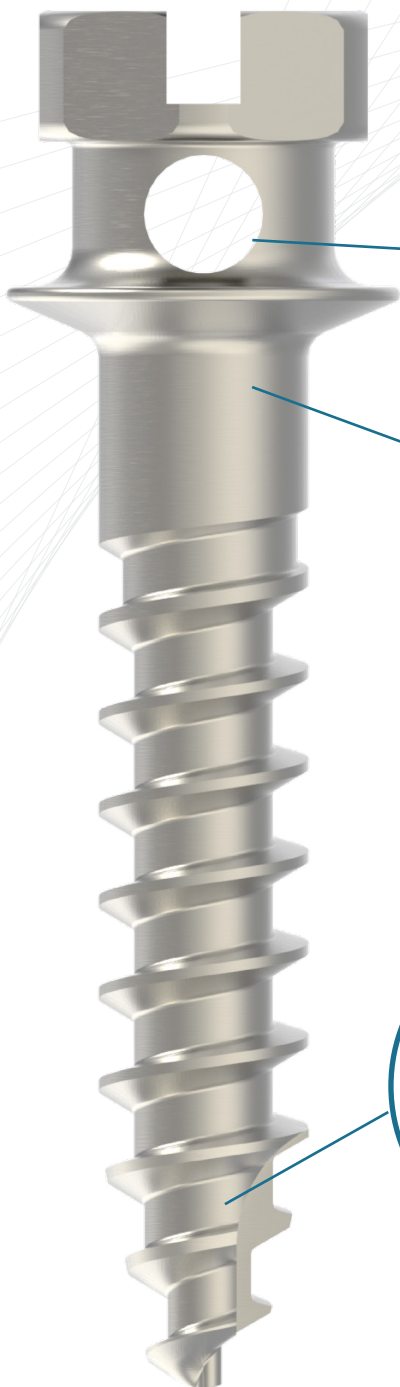
**A**

- Materialized various Heads (Hex, Neck & Hole)
- Able to overcome various surgery indication
- Able to use various Coil Spring & Elastic Band

**B**

- Materialized Straight appearance and tapered diameter of bone
- Get convenience of insertion and primary stability during surgery

**C**

- Implement Sharp thread and wide Apex design
- Improved primary insertion and Self-tapping
- Avoid a fracture of Apex when being inserted and removed

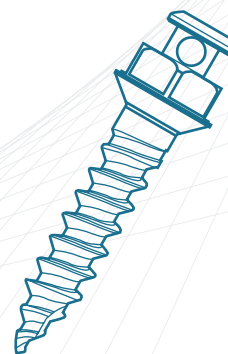
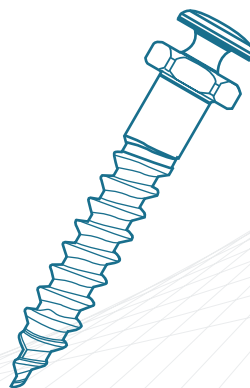
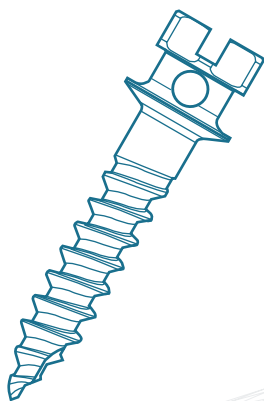
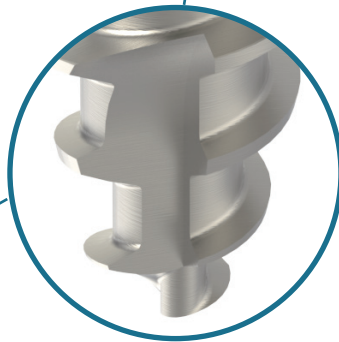

# Multi Anchor

-Various multi-anchor types for various treatment requirements

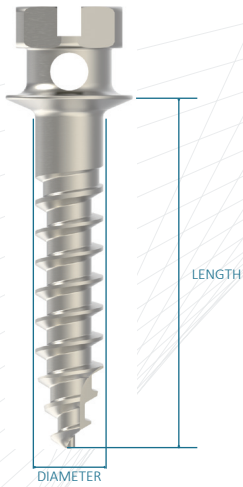

Bracket Hole Head - JTC (AJ2)		
CODE	Specifications (mm)	
	Diameter	Length
OR-J21606	Ø1.6	6
OR-J21608	Ø1.6	8
OR-J21610	Ø1.6	10
OR-J21612	Ø1.6	12

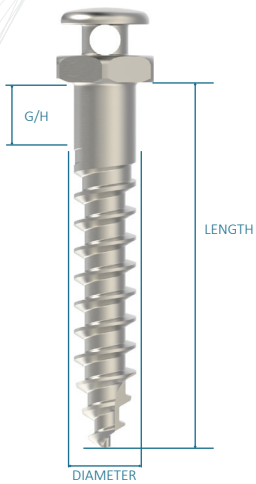

Button Hole Head - OBN-H (OH)			
CODE	Specifications (mm)		
	Diameter	Length	G/H
OR-H60615	Ø1.6	7.5	1.5
OR-H60815	Ø1.6	9.5	1.5
OR-H61015	Ø1.6	11.5	1.5
OR-H61215	Ø1.6	13.5	1.5

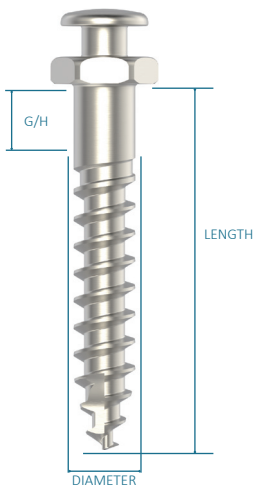

Button Head - OBN-N (ON)			
CODE	Specifications (mm)		
	Diameter	Length	G/H
OR-N60615	Ø1.6	7.5	1.5
OR-N60815	Ø1.6	9.5	1.5
OR-N61015	Ø1.6	11.5	1.5
OR-N61215	Ø1.6	13.5	1.5



## Driver Shaft

- Use for screw surgery by connecting with screwdriver handle or surgical engine
- Compatible with screwdriver handle of other manufacturers



Bracket Hole Head - JTC (AJ2) Type			
CODE	Specifications (mm)		
	Length	Applied Anchor	Remarks
OR-70JTCP	70	JTC(AJ2)	For Handle
OR-20JTCP	40	JTC(AJ2)	For Contra Angle



Button Hole/Button Head - OBN (OH,ON) Type			
CODE	Specifications (mm)		
	Length	Applied Anchor	Remarks
OR-H70OBN	70	OBN(OH,ON)	For Handle
OR-A40OBN	40	OBN(OH,ON)	For Contra Angle
OR-A20OBN	20	OBN(OH,ON)	For Contra Angle



Button Without Hole - JBN (BJ) Type			
CODE	Specifications (mm)		
	Length	Applied Anchor	Remarks
OR-702BJN	70	JBN(BJ)	For Handle

## Screwdriver Handle for Driver Shaft

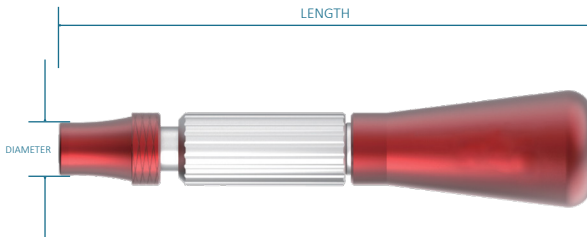

Screwdriver Handle for Driver Shaft		
CODE	Specifications (mm)	
	Diameter	Length
OR-SHDS	Ø11	111

- Use after connecting the driver shaft

## Finger Driver for Driver Shaft

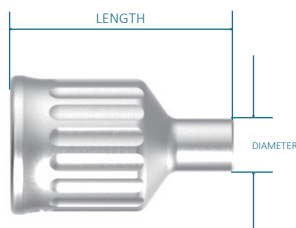

Finger Driver for Driver Shaft		
CODE	Specifications (mm)	
	Diameter	Length
OR-FS100	Ø3.8	16

- Use after connecting the driver shaft

# Orthodontic Surgical Kit Case

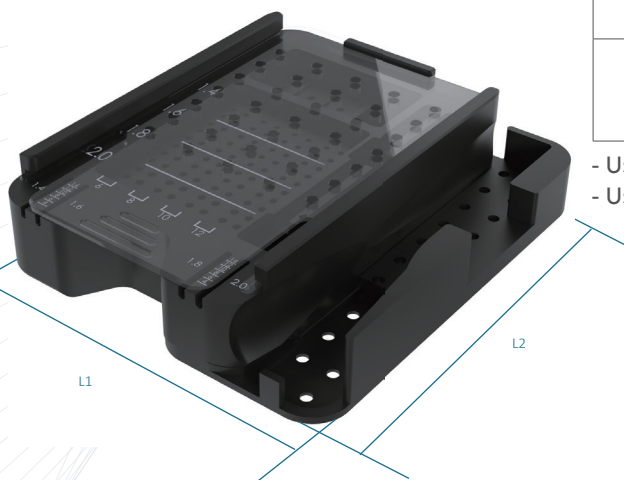

Finger Driver for Driver Shaft		
CODE	Specifications (mm)	
	L1	L2
OR-OSKC	100	115

- Use when instruments are being sterilized
- Use for identifying screw conveniently during treatment (surgery)

## Kit Layout

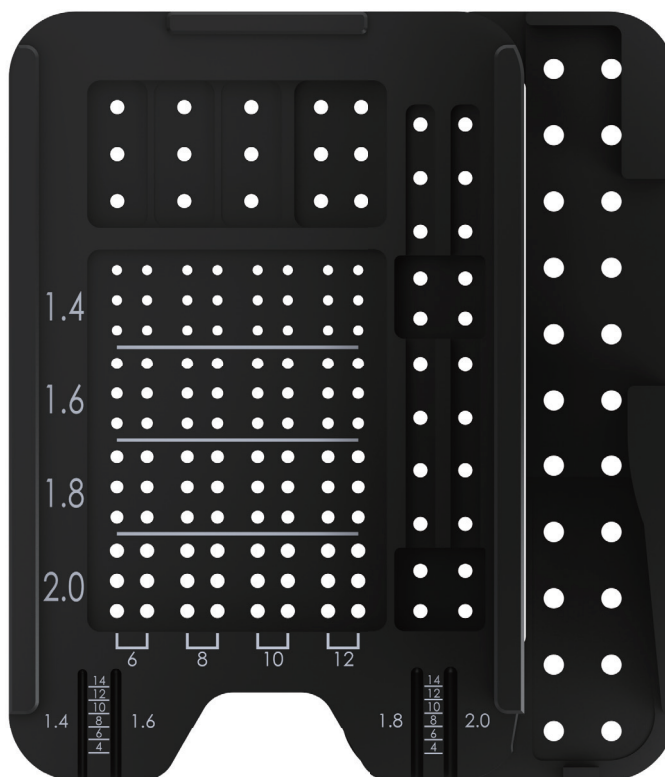

## Orthodontic Surgical Kit (Component)

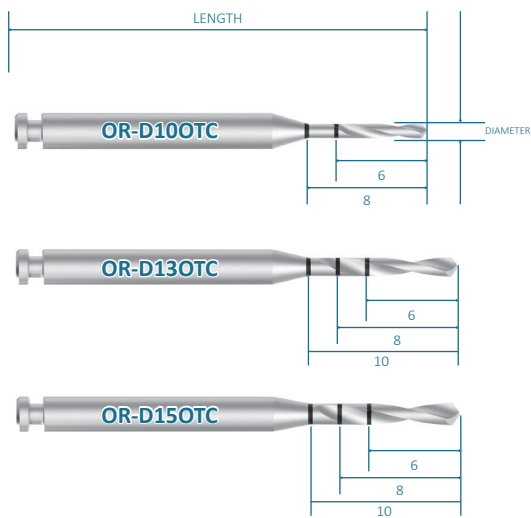

Orthodontic Surgical		
CODE	Specifications (mm)	
	Diameter	Length
OR-D100TC	Ø1.0	28
OR-D130TC	Ø1.3	30
OR-D150TC	Ø1.5	30

- For connecting with Surgical Engine
- Use for eliminating Cortical bone
- Recommended rotation speed : 800rpm

## Simple Head (BSH)

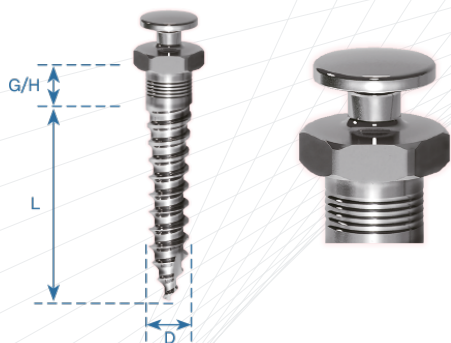

\* Ø 1.4 product, it is recommended to Pre-Drill to prevent fracture during implantation.

Simple Head - BSH					
D	Ø1.4	Ø1.6		Ø1.8	
G/H	1.5mm	1.5mm	4.0mm	1.5mm	4.0mm
L	4mm	OR-BSH1404	OR-BSH1604	-	OR-BSH1804
	6mm	OR-BSH1406	OR-BSH1606	OR-BSH16064	OR-BSH1806
	8mm	OR-BSH1408	OR-BSH1608	-	OR-BSH1808
	10mm	OR-BSH1410	OR-BSH1610	-	OR-BSH1810
	12mm	-	OR-BSH1612	-	OR-BSH1812

- Curved head design with little foreign body sensation.
- Ø 1.4 product product is advantageous for implantation between the roots of the anterior teeth.

## Through Hole (BTH)

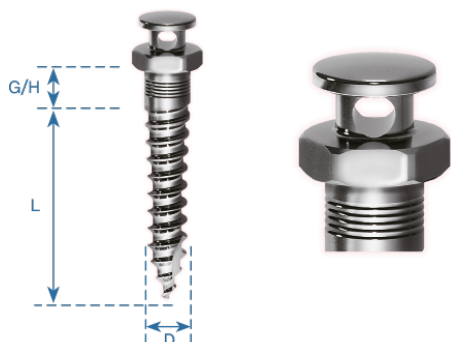

\* Ø 1.4 product, it is recommended to Pre-Drill to prevent fracture during implantation.

Simple Head - BSH					
D	Ø1.4	Ø1.6		Ø1.8	
G/H	1.5mm	1.5mm	4.0mm	1.5mm	4.0mm
L	4mm	OR-BTH1404	OR-BTH1604	-	OR-BTH1804
	6mm	OR-BTH1406	OR-BTH1606	OR-BTH16064	OR-BTH1806
	8mm	OR-BTH1408	OR-BTH1608	-	OR-BTH1808
	10mm	OR-BTH1410	OR-BTH1610	-	OR-BTH1810
	12mm	-	OR-BTH1612	-	OR-BTH1812

- Curved head design with little foreign body sensation.
- Neck diameter 1.45mm
- Ø 1.4 product product is advantageous for implantation between the roots of the anterior teeth.

## Bracket Head (BCH)

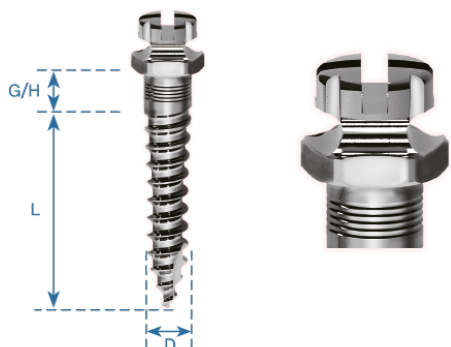

\* Ø 1.4 product, it is recommended to Pre-Drill to prevent fracture during implantation.

Simple Head - BSH					
D	Ø1.4	Ø1.6		Ø1.8	
G/H	1.5mm	1.5mm	4.0mm	1.5mm	4.0mm
L	4mm	OR-BCH1404	OR-BCH1604	-	OR-BCH1804
	6mm	OR-BCH1406	OR-BCH1606	OR-BCH16064	OR-BCH1806
	8mm	OR-BCH1408	OR-BCH1608	-	OR-BCH1808
	10mm	OR-BCH1410	OR-BCH1610	-	OR-BCH1810
	12mm	-	OR-BCH1612	-	OR-BCH1812

- 019\*Wire ligation is possible with bracket head type.

## Driver Shaft

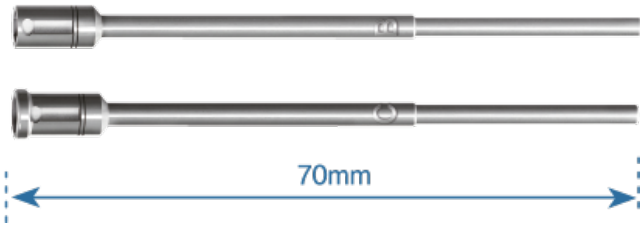

Driver Shaft for Universal Handle	
Code	Type
OR-SSBB	B TYPE
OR-SSCB	C TYPE

- Consist of two types, B type and C type.
- Compatible with other company's driver handles.

## Universal Screwdriver Handle

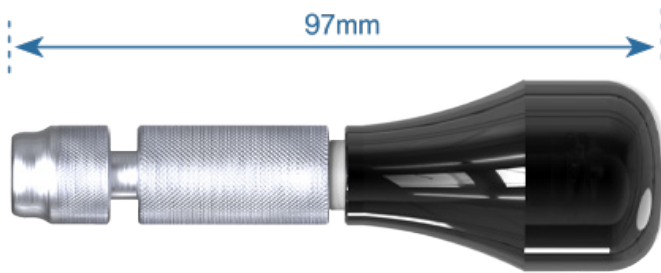

Universal Screwdriver Handle for Driver Shaft	
CODE	Specifications (mm)
	Length
OR-SHDS2	97mm

- It is used after fastening with the driver shaft, and the anti-slip treatment is provided in the center of the handle for easier procedure.

## Kit Layout





# Instruments

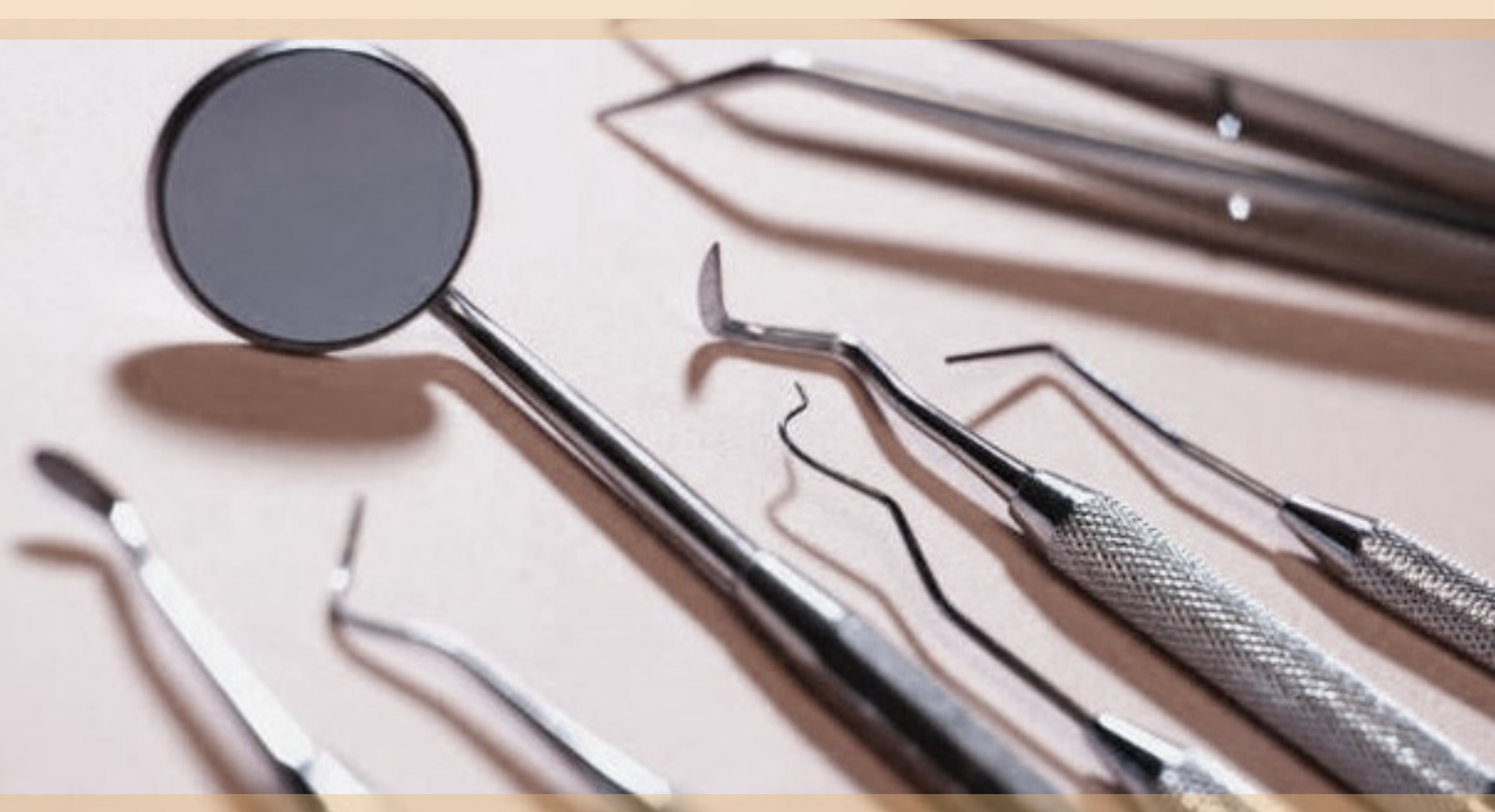

- Distal End Cutters
- Ligature & Wire Cutters
- Pliers
- Bracket & Bands Remover
- Composite Instruments



Distal End Cutter  
Mini - T.C. Tip

**OR-009-110**

Cutting Capacity:  
Max 0.7 mm



Distal End Cutter - Micro  
w/ Long handle- T.C. Tip

**OR-009-111**

Cutting Capacity:  
Max 0.7 mm



Distal End Cutter Flush  
Cut w/ Hold - T.C. Tip

**OR-009-112**

Cutting Capacity:  
Min 0.4 mm  
Max 0.64 mm



Pin & Ligature Wire Cutter  
Regular - T.C. Tip (Plasma Gold)

**OR-009-113**

Cutting Capacity:  
Max 0.3 mm



Hard Arch Wire Cutter  
T.C. Tip

**OR-009-114**

Cutting Capacity:  
Max 0.7 mm

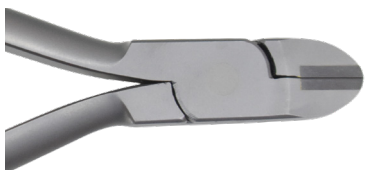

Lingual Wire Cutter  
T.C. Tip

**OR-009-115**

Cutting Capacity:  
Max 0.9 mm



Heavy Wire Cutter  
T.C. Tip

**OR-009-116**

Cutting Capacity:  
Max 1.2 mm



Bracket Remover  
(Straight) - T.C. Tip

**OR-009-117**

Direct Bond Bracket  
Remover



"HOW" Plier (Straight)  
T.C. Tip

**OR-009-118**

T.C. Tip

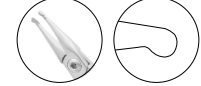

Weingart Utility Plier  
(Curved) T.C. Tip

**OR-009-119**

Curved

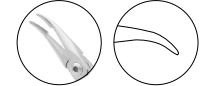

Weingart Utility Plier  
(Straight) T.C. Tip

**OR-009-120**

Straight



Posterior Band Removing  
Plier - Long Handle - T.C. Tip

**OR-009-121**

Includes 1 (PC) Extra  
replacement pad



"Bird Beak" Plier (Short)  
T.C. Tip

**OR-009-122**

Max Wire 0.7 mm



Nance Loop Closing  
Plier - T.C. Tip

**OR-009-128**

Max Wire 0.7 mm



"Bird Beak" Plier (Medium)  
T.C. Tip

**OR-009-123**

Max Wire 0.7 mm



Aderer Plier  
T.C. Tip

**OR-009-129**

Max Wire 0.6 mm



Adam Plier  
T.C. Tip

**OR-009-124**

Max Wire 0.7 mm



Hook Crimping  
Plier

**OR-009-130**

Hardened French Steel



Light Wire "Bird Beak" Plier  
T.C. Tip (Long Fine Tip)

**OR-009-125**

Max Wire 0.7 mm  
Long Delicate Point



Loop Forming Plier  
(Regular)

**OR-009-131**

Hardened French Steel



Tweed Arch Bending Plier  
(Straight) - T.C. Tip

**OR-009-126**

Max Wire 0.7 mm



Loop Forming Plier  
(with Steps)

**OR-009-132**

Hardened French Steel



Lingual Archwire Plier  
T.C. Tip

**OR-009-127**

Max Wire 0.9 mm



Cinch Back Plier  
(T Shape Plier)

**OR-009-133**

Max 0.7 mm





Detailing Plier  
Inserted Tip

**OR-009-134**

1mm, 1/2mm  
3/4mm



Band Seating  
Plier

**OR-009-135**

Hardened French  
Steel



Hollow Chop  
Plier

**OR-009-136**

Hardened French  
Steel

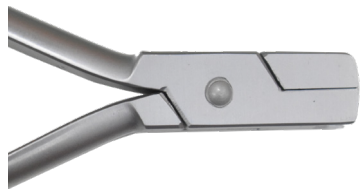

Torquing Plier  
with KEY

**OR-009-137**

Hardened French  
Steel

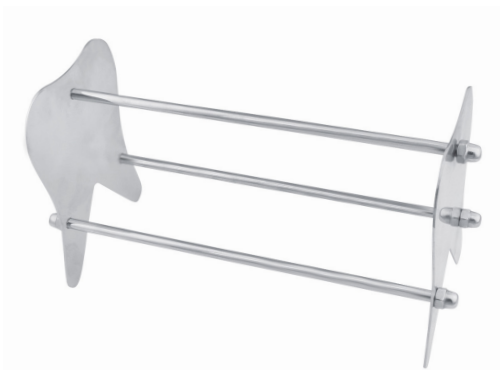

Plier Rack

**OR-009-138**

Highly Resistance Non-  
Magnetic Material



Ligature Director  
or Tucker

**OR-009-139**

Double Ended



Band Seater & Scaler  
Double Ended  
**OR-009-140**



Elastic Placer  
(Applicator)  
**OR-009-141**



Elastic Remover  
(Double Ended)  
**OR-009-142**



Distal Bender  
(Double Ended)  
**OR-009-143**



Composite Instrument  
Blue Color Tip  
**OR-009-144**  
Size : 9.5mm



Composite Instrument  
Black Color Tip  
**OR-009-145**  
Size : 9.5mm



Height Gauge  
(Aluminum Black Color)  
**OR-009-146**



Height Gauge  
Stainless Steel 0.018  
**OR-009-147**



Height Gauge  
Stainless Steel 0.022  
**OR-009-148**





Height Gauge  
Adjustable  
**OR-009-149**



Band Pusher/Seater  
Blue Color  
Plastic Handle  
**OR-009-150**



Band Pusher  
**OR-009-151**



Bracket Placement  
Tweezers  
**OR-009-152**



Direct Bonding Bracket  
Holder Straight Point  
**OR-009-153**



Direct Bonding Bracket  
Holder with Sheet  
**OR-009-154**



Direct Bonding Bracket  
Holder (Curved)  
**OR-009-155**



Direct Bonding Bracket  
Holder with Sheet  
**OR-009-156**



Direct Bonding Bracket  
Holder Fine Point  
**OR-009-157**



Mathieu Plier  
Regular  
**OR-009-158**

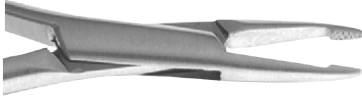

Mathieu Plier  
Short Tip  
**OR-009-159**



Mosquito Forcep  
Straight  
**OR-009-165**



Mathieu Plier  
Ultra Fine Tips  
**OR-009-168**



Mosquito Forcep  
Curved  
**OR-009-166**



Mathieu Plier  
Narrow Tip  
**OR-009-169**

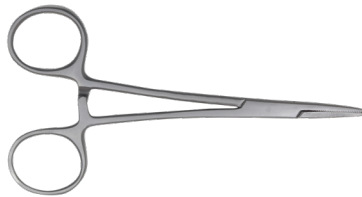

Mosquito Forcep with  
Hole (For Elastic)  
**OR-009-162**



Mathieu Plier  
Regular Tip  
**OR-009-170**



Mathieu Plier  
Needle Holder  
**OR-009-171**



Torquing Pliers  
**OR-009-163**  
Grooved  
**OR-009-164**  
Regular



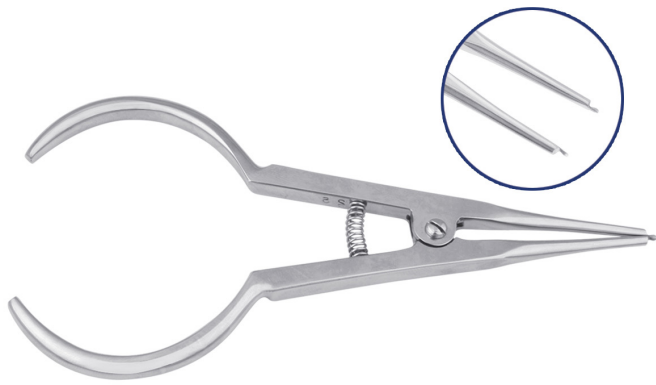

Elastic Separating  
Plier

---

**OR-009-160**



Positioning Gauge  
with Points

---

**OR-009-161**



Measuring  
Caliper

---

**OR-009-167**

# Instruments

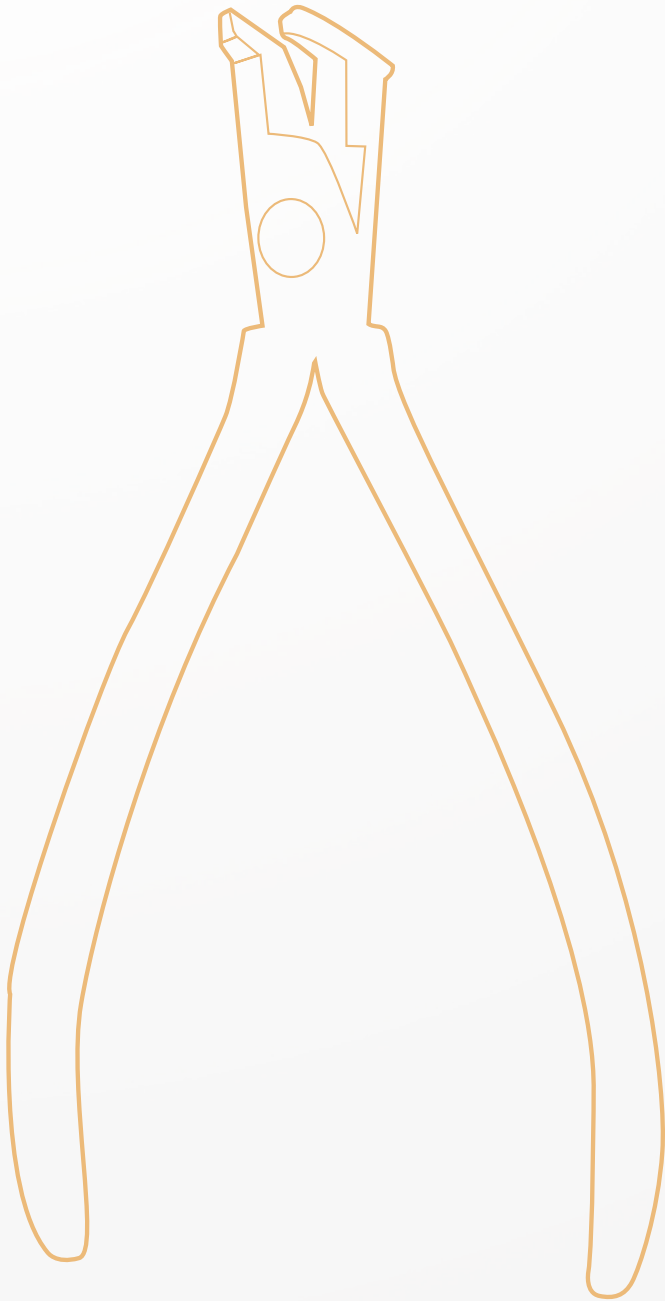

● **MADE IN JAPAN**



AUTOCLAVE  
TEMP - 132 °C



TC



30-950

REPLACEMENT  
HOLD-RING  
10/PK

LENGTH  
147mm

10°

**30-550FL**

DISTAL END SAFETY CUTTER-SLIM  
(FLUSH CUT TYPE - LONG HANDLE)

- Rectangular Wires up to .022"x.028"
- Round Wires up to .020"



TC

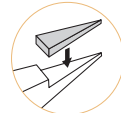

30-950

REPLACEMENT  
HOLD-RING  
10/PK

LENGTH  
121mm

**30-550SF**

DISTAL END SAFETY CUTTER-SLIM  
(FLUSH CUT TYPE)

- Rectangular Wires up to .022"x.028"
- Round Wires up to .020"



TC

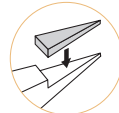

LENGTH  
130mm

**30-550S**

DISTAL END SAFETY CUTTER-SLIM

- Rectangular Wires up to .022"x.028"
- Round Wires up to .020"



TC

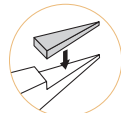

LENGTH  
147mm

10°

**30-550SL**

DISTAL END SAFETY CUTTER-SLIM  
(LONG HANDLE - CURVED)

- Rectangular Wires up to .022"x.028"
- Round Wires up to .020"



TC

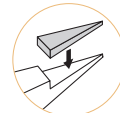

LENGTH  
147mm

**30-550SLS**

DISTAL END SAFETY CUTTER-SLIM  
(LONG HANDLE - STRAIGHT)

- Rectangular Wires up to .022"x.028"
- Round Wires up to .020"



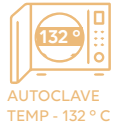

**60-605S**  
**PIN & LIGATURE CUTTER-SLIM**  
 Ligature Wires up to .015"

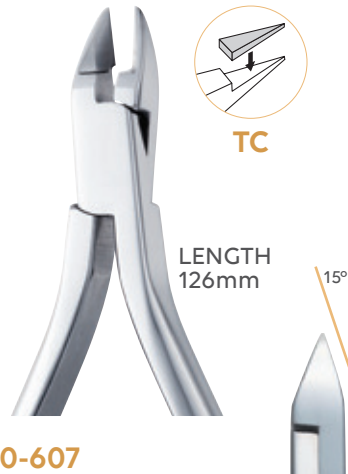

**60-607**  
**PIN & LIGATURE CUTTER-SLIM**  
**15° ANGLE**  
 Ligature Wires up to .015"



**TS-15**  
**PIN & LIGATURE CUTTER**  
 Ligature Wires up to .016"  
 Elastic Ligatures



**60-605**  
**PIN & LIGATURE CUTTER-MINIATURE**  
 Ligature Wires up to .015"



**60-604**  
**PIN & LIGATURE CUTTER**  
 Ligature Wires up to .015"





AUTOCLAVE  
TEMP - 132 °C

**N-215**

MATHIEU TYPE

LENGTH  
155mm



**60-217**

LIGATING PLIER

LENGTH  
155mm

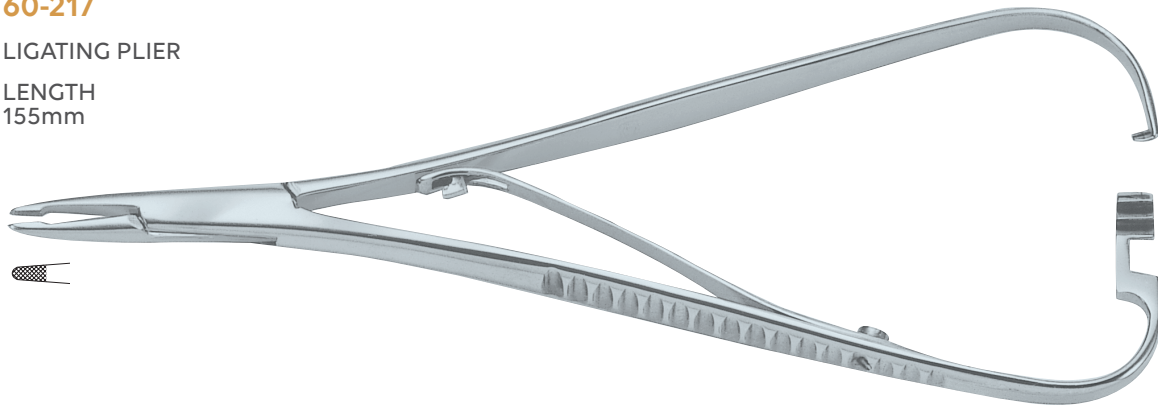

**30566**

SMAHA-STRAIGHT

LENGTH  
155mm



**30567**

SMAHA-CURVED

LENGTH  
140mm



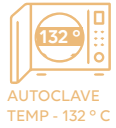

**60-430CK**

**KIM PLIER-WITH CUTTER**  
For bending of multiple edgewise arch wires.

☐ Rectangular Wires up to .016"x.022"



**60-302**

**NANCE CLOSING LOOP PLIER**  
Beaks are parallel at .020" opening  
Wires up to .022"



**60-320**

**OPTICAL PLIER**  
Wires up to .022"

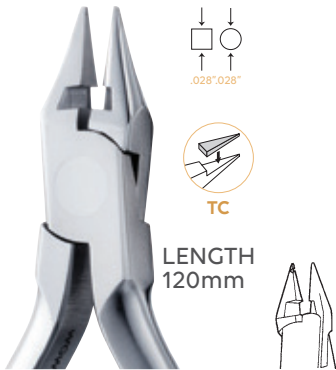

**30-315C**

**LIGHT WIRE PLIER WITH CUTTER-GROOVED SQUARE TIP**  
Wires up to 0.20"

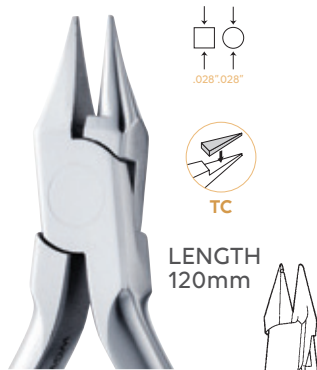

**30-315T**

**LIGHT WIRE PLIER-GROOVED SQUARE TIP**  
Wires up to 0.20"



**30-314T**

**BIRD BEAK PLIER**  
Wires up to 0.32"

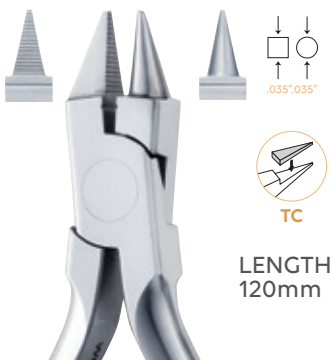

**60-314TS**

**WIRE BENDING PLIER**  
Wires up to .028" (0.7mm)



AUTOCLAVE  
TEMP - 132 °C

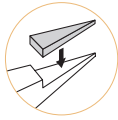

TC

LENGTH  
136mm



**60-501T**

WEINGART UTILITY PLIER



LENGTH  
136mm



**60-501**

WEINGART UTILITY PLIER

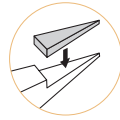

TC

LENGTH  
127mm



**30-502T**

WEINGART UTILITY PLIER



LENGTH  
175mm

**TS-20**

LINGUAL UTILITY PLIER - (LONG  
HANDLE)

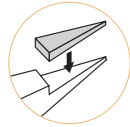
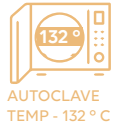

LENGTH  
131mm



**60-104T**  
POSTERIOR BAND REMOVING PLIER



AUTOCLAVE  
TEMP - 132 °C



LENGTH  
131mm

**60-208**

BAND CONTOURING PLIER



LENGTH  
131mm

**60-212**

CROWN CONTOURING PLIER



LENGTH  
131mm

**60-317**

CROWN CRIMPING PLIER

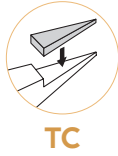
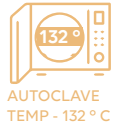

TC

LENGTH  
120mm

**60-313T**

THREE JAW PLIER

Wires up to .028"

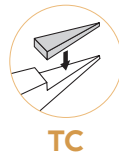

TC

LENGTH  
120mm

**60-228**

STEP PLIER

Wires up to .022"×.028"

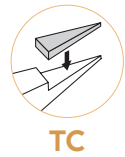

TC

LENGTH  
125mm

**60-224T**

THREE JAW PLIER

Wires up to .025"

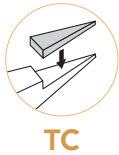

TC

LENGTH  
125mm

**60-202T**

QUAD HELIX BENDING PLIER

Wires up to .036"(0.9mm)



**60-983**

REPLACEMENT  
TIP 1/PK  
Round Size:  
.063" (1.6mm)



**60-971**

HEX WRENCH (1/PK)

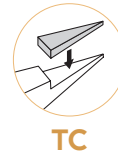

TC

LENGTH  
127mm

**60-335T**

DIRECT BOND BRACKET REMOVING  
PLIER-STRAIGHT



LENGTH  
131mm

**60-900**

TIE-BACK PLIER

Wires up to .025" (Ni-Ti Only)



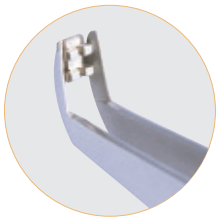
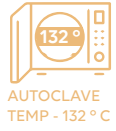

LENGTH  
140mm



**60-815**

BRACKET PLACING TWEEZERS

LENGTH  
142mm

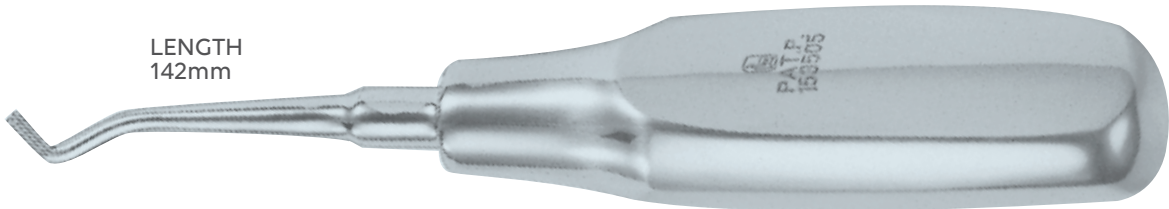

**60-811**

BAND PUSHER-TRIHEDRAL HANDLE

